



Operating Instructions

Controller for vibratory drive systems

SCU1000

Table of Contents

1.	About this document	4
1.1.	Document description:.....	4
2.	Safety directives.....	4
2.1.	Design of safety directives.....	4
2.2.	Fundamental safety directives.....	4
2.3.	Personnel	4
2.4.	Intended use.....	5
2.5.	Residual hazards.....	5
2.5.1.	Device	5
2.5.2.	Protection of the drive system.....	5
2.5.3.	Degree of protection - Protection of persons and equipment.....	5
3.	Product information	6
3.1.	Functional description.....	6
3.2.	Difference between SCU1000 and SCU2000.....	6
3.3.	Technical data	7
3.4.	Products, spare parts and accessories.....	8
4.	Notes on start-up.....	9
4.1.	Modes of operation.....	9
4.2.	Automatic mode change.....	9
4.3.	Start/Stop by external controller	10
4.4.	Changing the supply voltage	12
4.5.	Measuring the output voltage or output current	13
5.	Connections on the controller.....	13
5.1.	SCU1000.....	13
6.	SCU1000 connection diagram	14
7.	Operation of SCU1000	15
7.1.	SCU1000 menu structure.....	16
7.2.	Description of SCU1000 parameters.....	17
8.	Installation of I/O retrofit kit into SCU1000	18
9.	Dimensional drawing of SCU1000	19

1. About this document



Attention

Read this document carefully and observe the safety directives before commencing any work.

The information given in this document reflects the following version:

Product	from software version	Date
SCU1000	V1.0	2019-03-01

1.1. Document description:

This document provides assistance in choosing your product. You will also find information on mechanical and electrical installation, product extensions and accessories.

2. Safety directives

2.1. Design of safety directives



Notice

This notice identifies useful tips for use of the controller.



Attention!

This symbol identifies hazardous situations.

Non-observance of such warnings may cause irreversible injury or even death!

2.2. Fundamental safety directives

Non-observance of the following fundamental safety measures and directives may lead to severe injury and damage to property!

Meeting the requirements given in the related documentation is a precondition for safe and trouble-free operation and for achieving the product properties specified. Further additional safety directives in the other sections must be observed as well.

2.3. Personnel



Attention!

Any work on electrical equipment of the machine/system shall be carried out exclusively by a professional electrician, or by instructed persons working under the direction and supervision of a professional electrician, according to electrotechnical rules.

Only qualified professionals are allowed to work on or with the product. IEC 60364 or CENELEC HD 384 define the qualification of these persons:

- They are familiar with set-up, installation, commissioning and operation of the product.
- They possess the qualification required for performance of their work.
- They know all regulations for the prevention of accidents, directives and laws applicable to set-up, installation and commissioning on site, and they are able to apply the same.
- They have knowledge and skills of First Aid.

2.4. Intended use

Please observe the following directives for intended use of the controllers:

- The devices herein described must only be stored, fitted and operated under the conditions specified in this documentation.
- Here you are not concerned with domestic devices! They are solely intended to be used as components for commercial or professional applications pursuant to EN 61000-3-2.
- They satisfy the protection requirements of 2014/35/EU: Low Voltage Directive.
- They do not constitute a machine as defined by 2006/42/EU: Machinery Directive.
- A machine comprising the product must not be commissioned or put into operation for the intended use until it has been declared to be in conformity with the EC Directive 2006/42/EU: Machinery Directive; Observe EN 60204-1.
- Commissioning or starting operation for the intended use is only permitted in compliance with the EMC Directive 2014/30/EU.
- Use of the product in living areas may lead to EMC disturbance. The user is responsible for taking interference suppression measures.
- They are optimised for operation of RNA vibratory feeders and linear feeders. Observe the limits indicated in the technical specification.

Attention!





- Prior to start-up make sure that the protective earth conductor is connected and in proper condition. Make the PE conductor test with approved test devices only.
- Never start up despite detected damage.
- Do not make any technical modifications to the device, except as described in this document.
- Never start up in an incompletely installed state.
- Never operate the device without the required guards in place.
- Connect, disconnect or change any electrical connections only in the absence of voltage.

2.5. Residual hazards

Residual hazards may remain even if all directives have been observed and protective measures taken. Such residual hazards must be considered by the user in the risk assessment of his machine/equipment. Non-observance may lead to severe injury and damage to property!

2.5.1. Device

Pay attention to the warning signs fitted to the device!

Symbol	Description
	Hazardous voltage: Prior to commencing any work on the product check for absence of voltage on all power connections.
	Leakage current: Make fixed installation and PE connection according to EN 60204-1!

2.5.2. Protection of the drive system

Certain device parameter settings may overheat the connected drive magnet, e.g., by prolonged operation with improper boost factor.

2.5.3. Degree of protection - Protection of persons and equipment

- All specifications relate to installed condition ready for operation.
- All slots not used must be closed by protection caps or dummy plugs in order not to reduce the protection against accidental contact.

3. Product information

3.1. Functional description

The compact controller can operate all RNA vibrating motors up to a load current of 6 amps. It is designed for individual installation right local to the vibrating drive.

The controller is customized for RNA vibratory drive systems. The feed rate can be precisely adjusted within the setting range via LED display. Thanks to this new control technology the feed rate is kept largely constant even with fluctuating supply voltage.

The illuminated rocker switch in the front panel isolates the controller from power supply on both poles. For frequent switching applications or when operating with a higher-level control system provision is made for enabling via a 16V-30V DC signal.

The integrated ramp function ensures time-controlled increase or decrease of the feed rate to setpoint after starting or stopping. These times are set at 0.1 seconds and can be changed on the controller if necessary.

The controller can operate on both 230V and 115V supply which can be selected on an internal switch. All other controller settings are made via the LED display.

3.2. Difference between SCU1000 and SCU2000

The SCU1000 has a permanently connected power cable with shockproof plug. The vibrating drive is connected to the SCU1000 by plug. If an enabling signal is required the corresponding wiring can be fed into the device through an M8x1 cable gland and connected to the internal terminals. Status signals are not brought out of the controller.

The SCU2000, however, has all connections pluggable. This means: power supply, vibrating motor, enabling signal and status signals can all be plug-connected.

If you need plug-type connections for the external enabling signal and/or status signals on the SCU1000, these connections can be made accessible by installation of an I/O retrofit kit. See chapter 8.

3.3. Technical data

Technical data	
Power supply (can be changed internally):	230V AC, 50/60Hz, +10 -10% or 115V AC, 50/60Hz, +10 -10%
Output voltage:	U _{eff} 40...208 V variable, (230V supply) U _{eff} 20...105 V variable, (115V supply)
Load current:	max. 6 A(I _{eff})
Device fusing (power input):	2x miniature fuse 5 x 20mm M6.3A/250V AC
Operating modes: (depending on 50/60 Hz supply frequency)	<u>Mode 1:</u> asymmetric half-wave mode (vibrating frequency = mains frequency) 3000/3600 1/min <u>Mode 2:</u> symmetric full-wave mode (vibrating frequency = double mains frequency) 6000/7200 1/min
Mode change:	Coding jumper in load connector
Enabling of functions:	internal/external adjustable via parameters
Enabling input, external contact:	floating contact Voltage source load capability: 24V DC, <10 mA
Enabling input, external 24V signal:	Level 16...30VDC (polarized) Signal current at 24V DC: < 10 mA
Status outputs	-
Power loss:	max. 18W
Soft start / stop	Standard start 1 s, standard stop 0.2 s adjustable via parameters
Degree of protection:	IP 54
Radio interference suppression:	acc. to EMC directive
Dimensions:	130 x 203 x 135 (width x height x depth)
Ambient temperature:	0°C to 40°C
Storage temperature	-20°C to 70°C
Air humidity:	15% to 85% not condensing
Atmospheric pressure:	86 kPa to 106 kPa
Cooling:	free convection
Weight:	approx. 1.6 kg
Housing material:	Aluminium/plastics
Installation position:	Vertical
Mounting	vibration-free

Attention!

Any intervention on the controller shall void the manufacturer's warranty.

This does not apply to



- proper installation of the I/O retrofit kit
- proper change of supply voltage
- proper connection of external enabling signal

in compliance with this operating instruction manual

3.4. Products, spare parts and accessories

Designation	Design	RNA article number
SCU1000	not pluggable without enabling and status signals	31002800

Designation	Con- nector	Design	RNA article number
Vibrating drive con- nector	X1	Plug with 4 pins + PE Metal housing	31002323
M8x1 cable gland with lock nut Connection of exter- nal enabling signal for SCU1000		For outside cable diameter: 3,5 mm ... 5 mm Plastic	31002803

Designation	Description	RNA article number
Measuring adapter ESZ-02 (400V/10A)	Accessory for measurement of output voltage and output cur- rent. The adapter is supplied with connectors.	31002525
I/O retrofit kit	Accessory for SCU1000 for retrofitting the pluggable enabling and status signals	31002801

4. Notes on start-up



Attention!

Set the controller to minimum output before switching-on for commissioning or start-up after repairs or replacement of controllers/vibratory drives. Then watch proper operation while the output is increased.

4.1. Modes of operation

RNA vibratory drive systems employ mechanical spring vibrators which are set to a vibrating frequency near the mains frequency or near double mains frequency depending on weight and/or size.

This is why two modes of operation are possible:

Mode 1: Asymmetric half-wave mode:
The vibrating drive operates at mains frequency.

Mode 2: Symmetric full-wave mode:
The vibrating drive operates at double mains frequency.

To assist the operator the cable glands on the drive connector are colour-coded.

Mode 1: black
Mode 2: grey

In terms of the vibrating frequency this means:

	Mains frequency 50 Hz	Mains frequency 60 Hz	Cable gland colour
Mode 1 Half-wave mode	Vibration frequency 50 Hz \triangleq 3000 min ⁻¹	Vibration frequency 60 Hz \triangleq 3600 min ⁻¹	black
Mode 2 Full-wave mode	Vibration frequency 100 Hz \triangleq 6000 min ⁻¹	Vibration frequency 120 Hz \triangleq 7200 min ⁻¹	grey

4.2. Automatic mode change

Vibratory drive systems by RNA do not require the operator to take care of selecting the right operating mode. The operating mode is determined by a code in the RNA vibrating drive connector. A wire jumper from pin 3 to 4 in the connector switches the controller to mode 2: 100 or 120 Hz. In the absence of this wire jumper the controller operates in mode 1: 50 or 60 Hz.

The RNA vibratory drive systems come with the right code in the connector.

Mode changes are made only and exclusively via the coding in the vibrating drive connector.

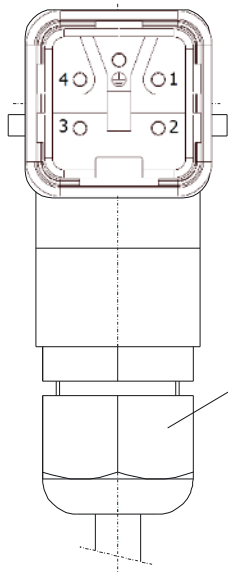

M20 gland

Black: 50/60Hz vibrating frequency
Grey: 100/120Hz vibrating frequency
(EMC metal gland if frequency controllers are used.)

(Where frequency controllers with selectable output frequency are used, an EMC metal gland and a shielded cable are provided.)

4.3. Start/Stop by external controller

With the default setting the vibrating drive is started/stopped by the power switch of the controller. The external enabling input makes it possible to control the vibrating drive by a higher-level control system. Feed the connecting cable through a cable gland into the controller and connect it to the terminal block provided for this purpose (see below).



Notice

Non-observance of these directives may lead to malfunctions or defects of the controller.

There are two options provided for external enabling:

Voltage signal:

This type of enabling should be preferred.

If a direct voltage between 16 and 30 V is available with the correct polarity the vibrating drive starts. The input is protected against polarity reversal.

Observe the following directives:

- Cable length max. 10m.
- Avoid cable routing in the immediate vicinity of high-energy switching devices or strong interference fields.

Floating contact:

If no 24 V signal is available, enabling is also possible via a floating contact. Closing of the contact enables the controller and starts the vibrating drive.

Observe the following directives:

- Cable length max. 5m.
- Use shielded cable for lengths of 3m and more.
- Avoid cable routing in the immediate vicinity of high-energy switching devices or strong interference fields.

See also connection diagram of SCU1000, chapter 5.

For both external enabling options the signal cable must be connected to terminal block X2 inside the controller. Remove the blanking plug from one of the two top holes and install the M8x1 cable gland (supplied with the SCU1000) with lock nut. Insert a cable with a cross-section of 2x0.25mm² min. to 2x0.5mm² max. The max. cable diameter is 5mm. Use terminals 5 (+24V) and 6 (GND) to connect the external enabling voltage. Use terminals 7 and 8 to connect the floating contact. See also illustration on page 11 (position of terminals inside device).

Make sure that the required protection rating (IP54) is maintained. Take care to ensure that the cable gland corresponds to at least protection class IP54 when installed. It is also mandatory to observe the required torques and cable diameters according to manufacturer specifications.

For safety reasons the cable gland used must be plastic.

It is not permitted to enlarge the existing hole or otherwise modify the housing.

Connection of external enabling signal to SCU1000:



Attention!

Any work on electrical equipment shall be carried out exclusively by a professional electrician, or by instructed persons working under the direction and supervision of a professional electrician, according to electrotechnical rules.

Observe the safety directives in chapter 2.

SCU1000:

5 = +24VDC, enabling via external voltage
6 = GND, enabling via external voltage

7 = enabling via external contact
8 = enabling via external contact

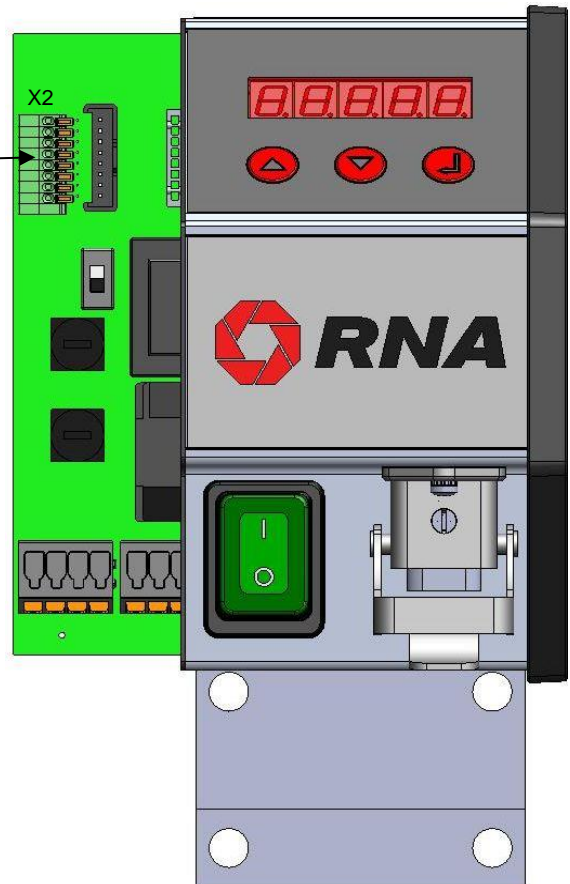

Connection for external enabling signal:

- Disconnect the device from power supply.
- Open left side of the device
- Fit a plastic cable gland (M8x1) in the existing hole
- Feed the signal cable through the gland and connect it
- Close left side of the device
- Connect device to power supply
- Make a test run to test the enabling signal

Terminal X2	Nominal cross-section:	0.5 mm ²
	Stripping length:	11 mm
	Conductor cross-section AWG min. / max.	26 / 20

External enabling parameter assignment.

The external enabling functionality must be set by the Hi parameter in the parameters menu. See chapter 7.

If you need plug-type connections for the external enabling signal and/or status signals on the SCU1000 at a later date, these connections can be made accessible by installation of an I/O retrofit kit. See chapter 8.

4.4. Changing the supply voltage

The controller is designed to operate both on 230V, 50/60Hz and on 115V, 50/60Hz. The given operating voltage must be set on the selector switch in the controller.

As delivered, the devices are set to the supply voltage indicated in the purchase order.

Attention!

Any work on electrical equipment shall be carried out exclusively by a professional electrician, or by instructed persons working under the direction and supervision of a professional electrician, according to electrotechnical rules.



Having changed the supply voltage take utmost care in re-assembling the controller because otherwise the operating permit or manufacturer's warranty will become void!
Setting the wrong supply voltage may result in electrical or mechanical damage to the controller or vibrating motor.

Changed devices should be marked conspicuously to avoid confusion.

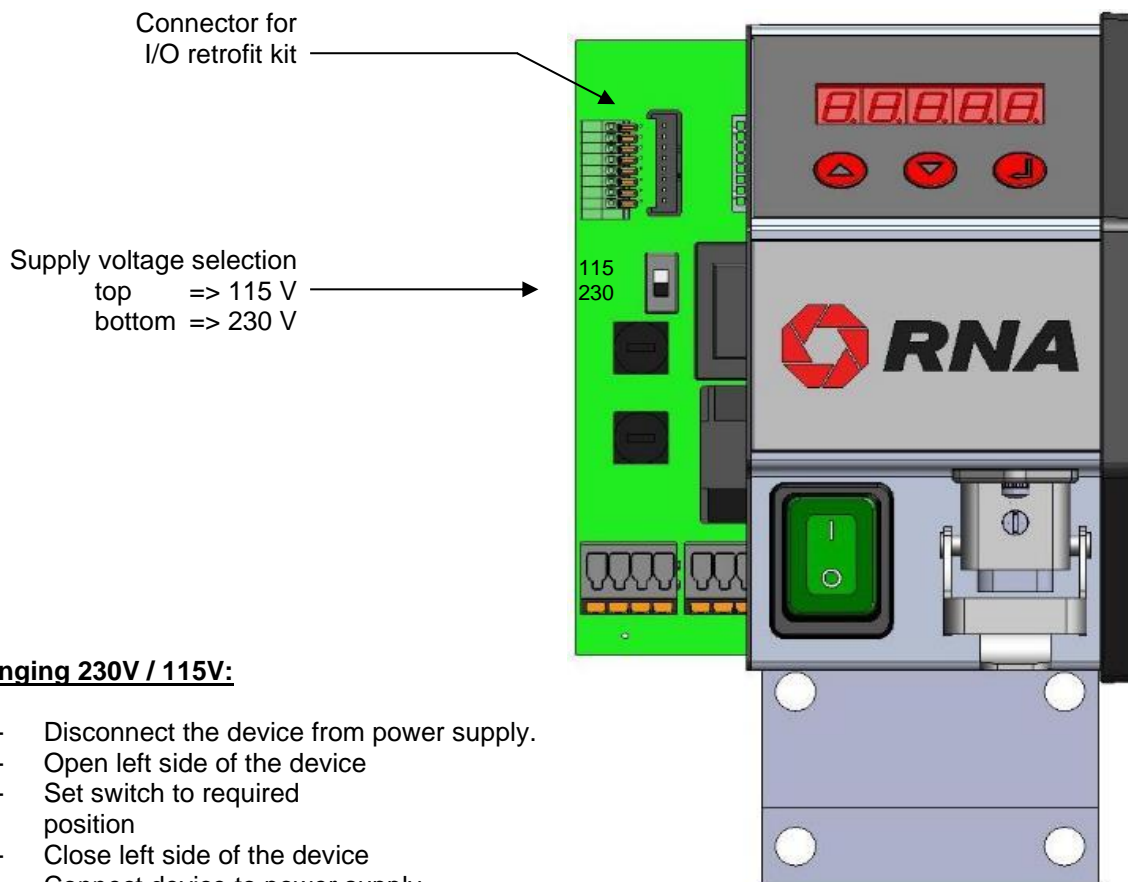

Changing 230V / 115V:

- Disconnect the device from power supply.
- Open left side of the device
- Set switch to required position
- Close left side of the device
- Connect device to power supply
- Trial run

4.5. Measuring the output voltage or output current

In some cases it may be necessary to measure the output current or output voltage.



Attention!

This measurement must be made by qualified professionals only. Having completed the measurement take utmost care in re-assembling the controller because otherwise the operating permit will become void!



Notice

The measuring device must be designed for **true root mean square measurement** (true RMS). Other measuring devices would show random values.

The output voltage can only be measured with the vibrating drive connected! The load connector must be plugged in because otherwise the measurement may perhaps be made in the wrong operating mode.

The use of the measuring adapter ESZ-02 (see chapter 1.6) greatly facilitates measurement of the output voltage and current. The measuring adapter is fitted with appropriate connectors for easy connection between controller and vibrating drive. The use of moving-iron measuring instruments makes sure that the true root mean square value is measured.

5. Connections on the controller

5.1. SCU1000

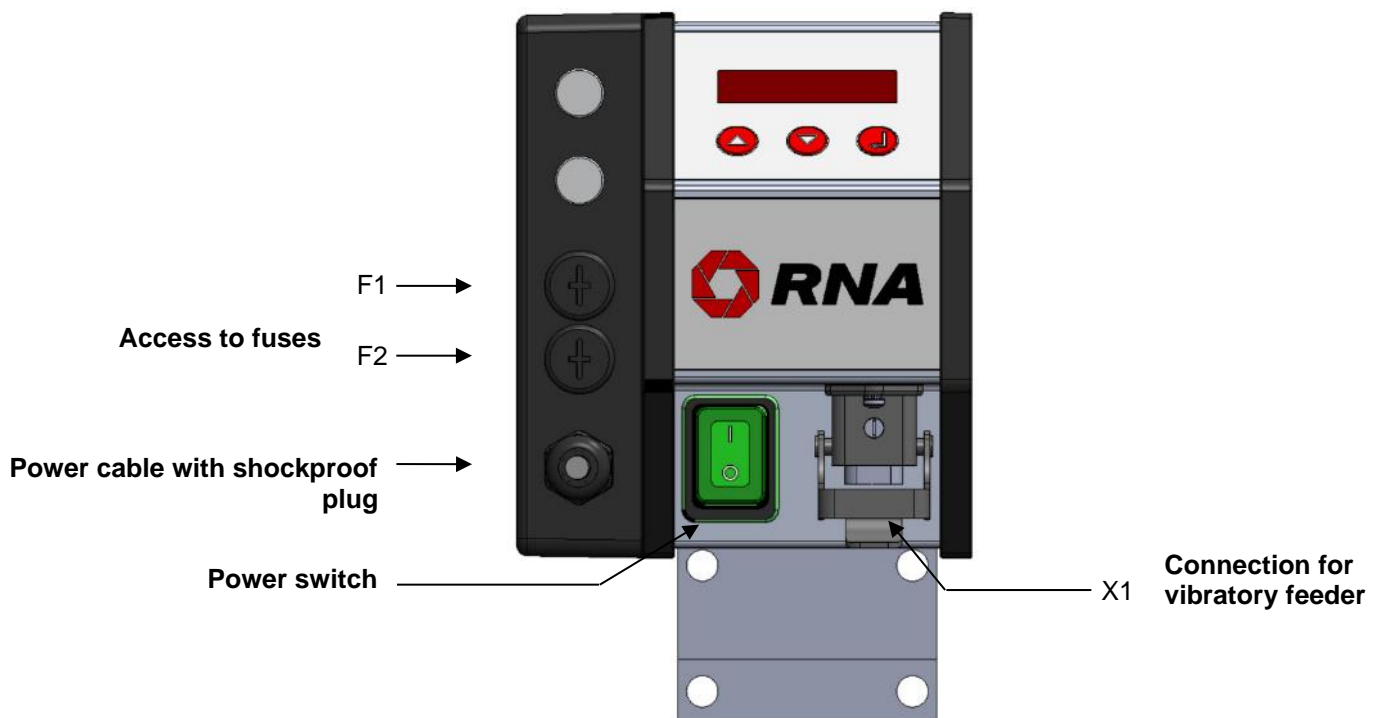

Attention!

When replacing the fuse be sure to use the specified rating of **M6.3A/250V**. Too high a fuse rating may destroy the controller.

6. SCU1000 connection diagram

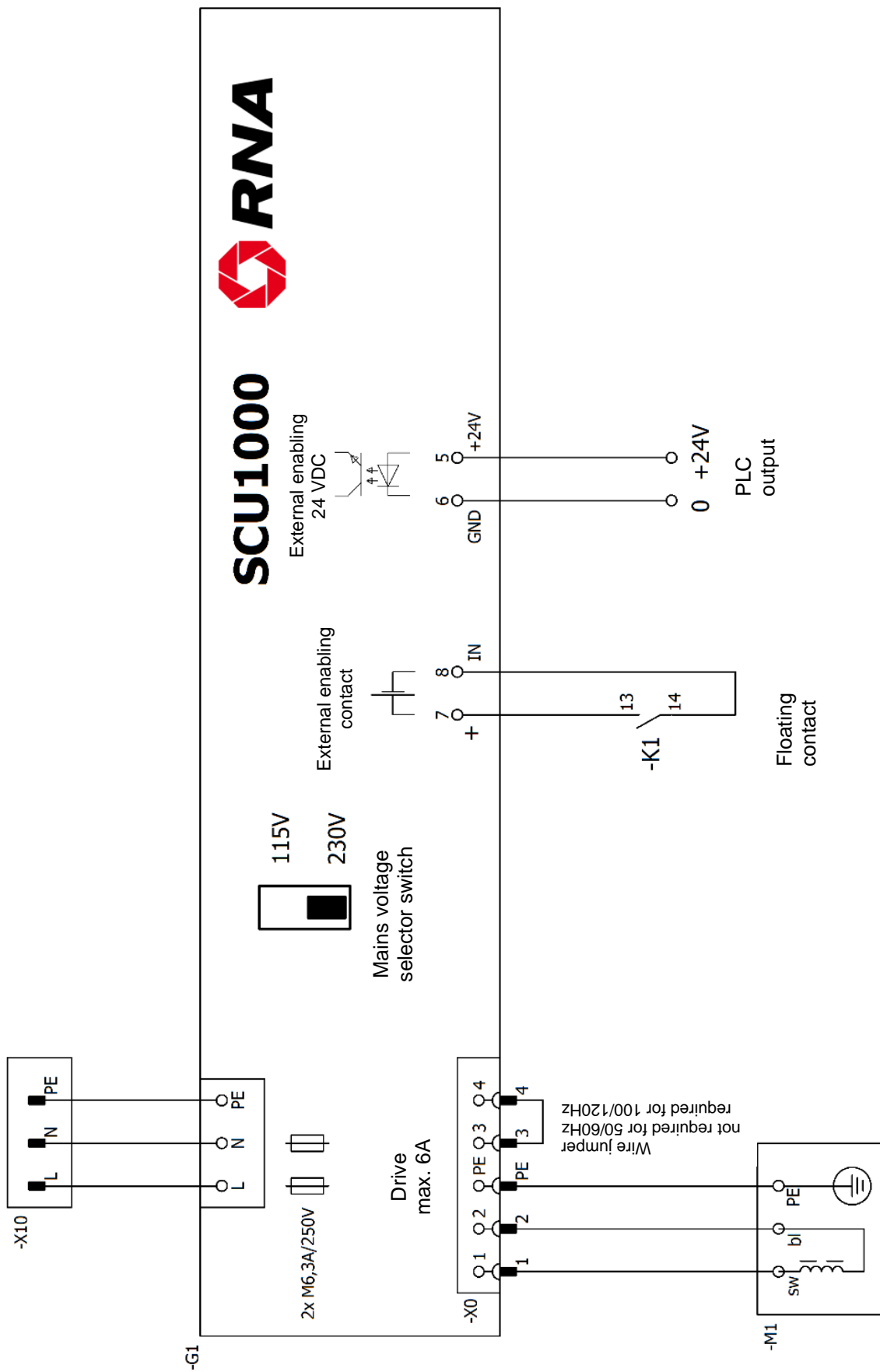

7. Operation of SCU1000

LED display:

A short while after starting of the controller the status display comes up and the set feed rate is shown.

75.0

Other potential display readings:

STOP

External enabling signal missing or wrong parameter assignment.

75.0

The parameter b (Boost) has been changed from 1.0 to another value.



Attention!

Improper setting of this parameter creates the risk of overheating the magnets.

LoPo

Supply voltage too low.
(This message appears for a few seconds when the device is switched on or off.)

Buttons:

Using the arrow buttons you can change setpoints and scroll through the menu.
Press the ENTER button to apply the values changed.

Changing the feed rate:

Upon pressing of the ENTER button the decimal point starts blinking on the status display and you can set the feed rate using the arrow buttons. Press ENTER again to complete the entry. The decimal point stops blinking.

Opening the parameters menu:

Press both arrow buttons at the same time. The parameters menu will come up after one second. The display shows the first parameter with its set value. Using the arrow buttons you can scroll through the list of parameters. For description of parameters see below.

Changing parameters:

Press the ENTER button to change a parameter. While the decimal points are blinking you can change the parameter using the arrow buttons. Press ENTER again to complete the entry. The decimal points stop blinking.

Exiting the parameters menu:

Scroll through the parameters menu until the display shows End. Press ENTER to see the status display. The status display will also appear if you press both arrow buttons at the same time for one second.

7.1. SCU1000 menu structure

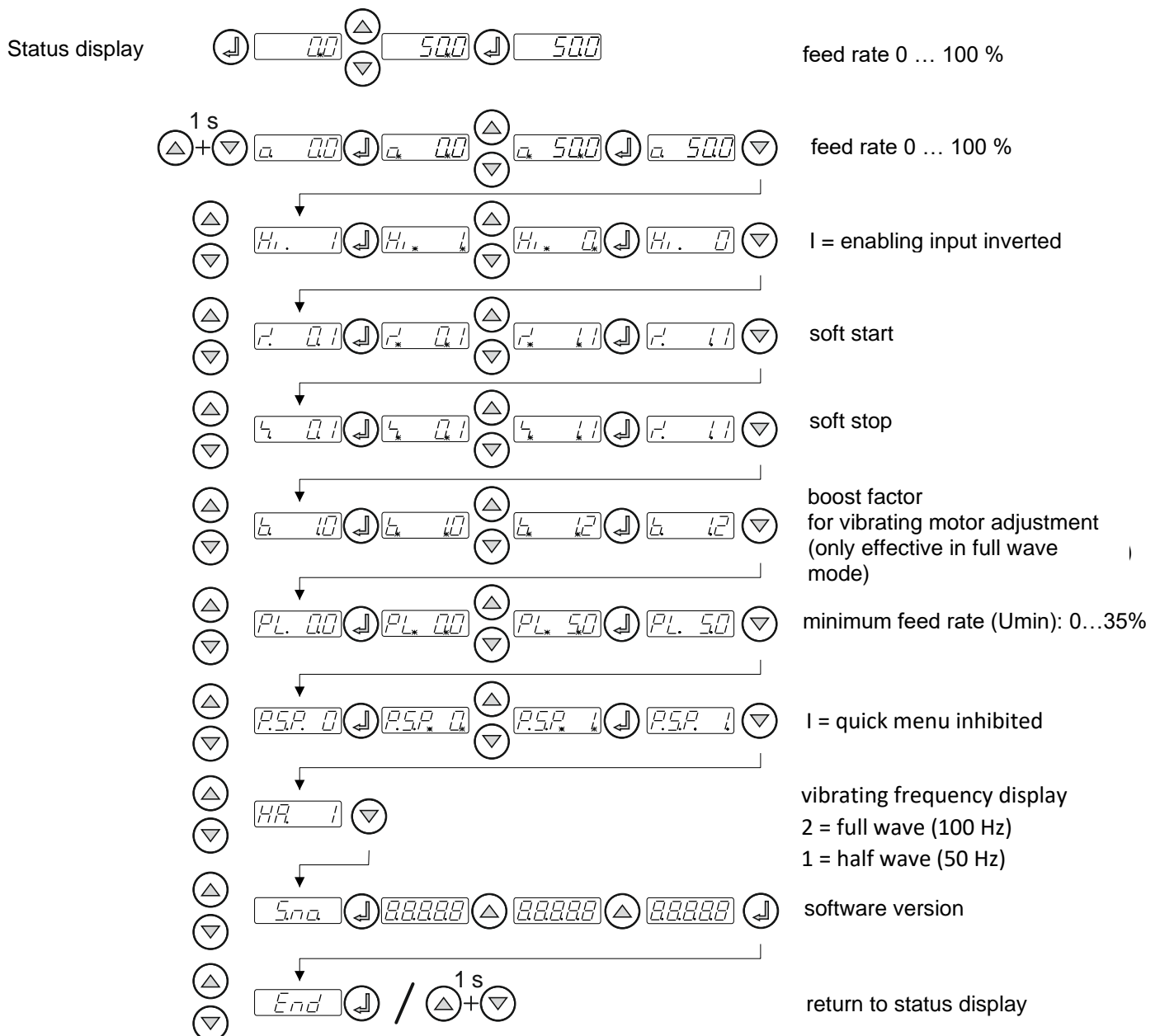
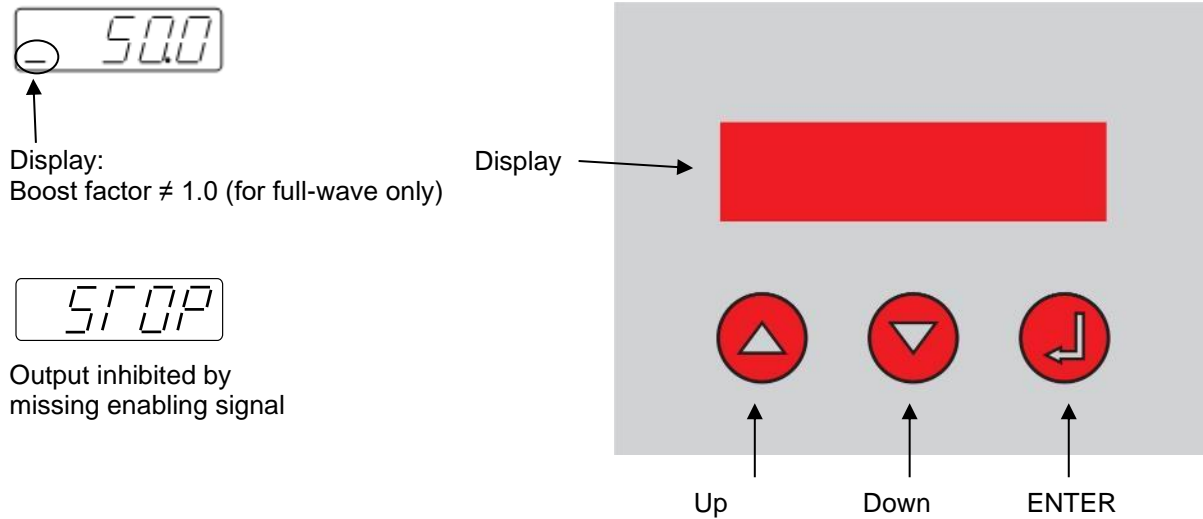

7.2. Description of SCU1000 parameters



Attention

Setting of wrong parameters may result in electrical or mechanical damage to the controller or vibrating motor.

Therefore, set a low feed rate on the controller before starting. Then watch proper operation while the output is increased.

Description of parameters in the parameters menu.

o. 75.0	Feed rate setting in %. Can be set from 0 to 100%. Can also be changed in the status display (if PSP parameter at 0).
Hi. 1	External enabling function. 1 = vibrating drive runs without external signal and stops when external signal is active. 0 = vibrating drive stops without external signal and runs when external signal is active.
┌ 0.2	Soft start time, run-up time from feeder start. Can be set from 0 to 10s, default setting is 0.1s.
└ 0.2	Soft stop time, run-down time from feeder stop. Can be set from 0 to 10s, default setting is 0.1s.
b. 1.0	Boost factor, can be set from 0.8 to 1.2. Only effective in full-wave mode (100/120Hz). Default setting 1.0 Changing the boost factor is not necessary in normal operation. Such change is only required in case of special vibrating drive systems.



Attention!

Improper setting of the boost factor will overheat the connected magnets.

PL. 35	Lower limit of feed rate. Can be set from 0 to 35%.
P.s.p. 0	Inhibiting feed rate change in the status display. 0 = enable (default setting) 1 = inhibit Feed rate setting is only possible in parameter o.
HA. 1	Display of operating mode or vibrating frequency (only with vibrating drive connected): 1 = 50/60Hz (half wave) 2 = 100/120Hz (full wave) The change of operating mode or vibrating frequency takes place only via coding in the vibrating motor connector. See chapter 4.2.
5.no.	Indication of the controller software version.
End	Return to status display.

8. Installation of I/O retrofit kit into SCU1000

Attention



Any work on electrical equipment shall be carried out exclusively by a professional electrician, or by instructed persons working under the direction and supervision of a professional electrician, according to electrotechnical rules.

This installation must be made by qualified professionals only. Having completed the installation take utmost care in re-assembling the controller because otherwise the operating permit will become void!

Any other intervention on the controller shall void the manufacturer's warranty.

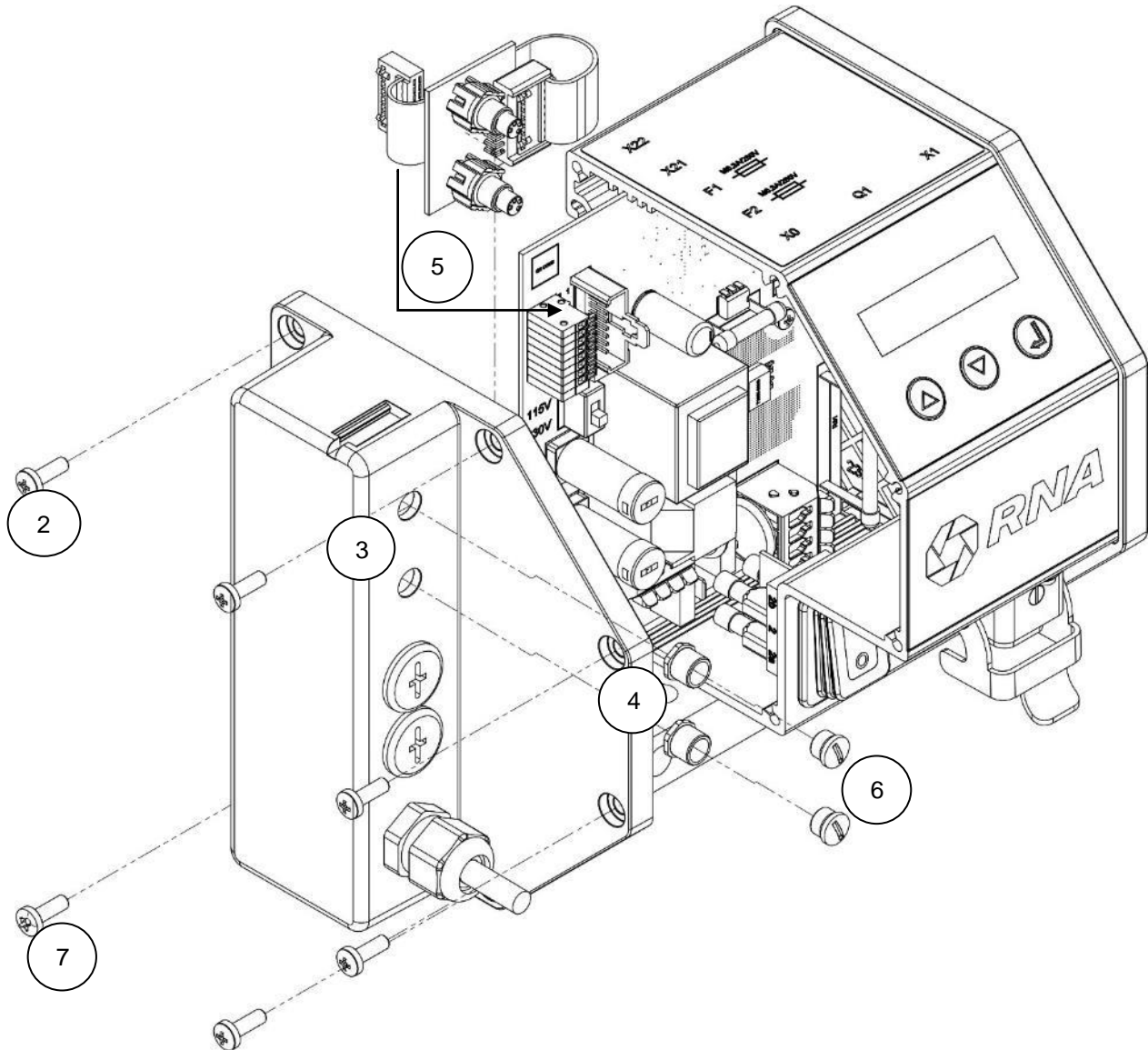

Step 1:

Disconnect the device from power supply.

Step 2:

Dismount the left-hand housing lid by removing the 6 screws.

Step 3:

Loosen the top two blanking plugs of the left-hand housing lid.

Step 4:

Remove dust protection caps and nuts of the I/O board and introduce the board into the holes provided for this purpose in the housing lid. After that fit the nuts of the I/O board in place again.

Step 5:

Plug the connector of the ribbon cable into the mating connector on the main board.

Step 6:

Attach dust protection caps (where required).

Step 7:

Fit the housing lid in place again. Tighten the six screws.

Step 8:

Make power connection, trial run and test all functions.

9. Dimensional drawing of SCU1000

All dimensions in mm

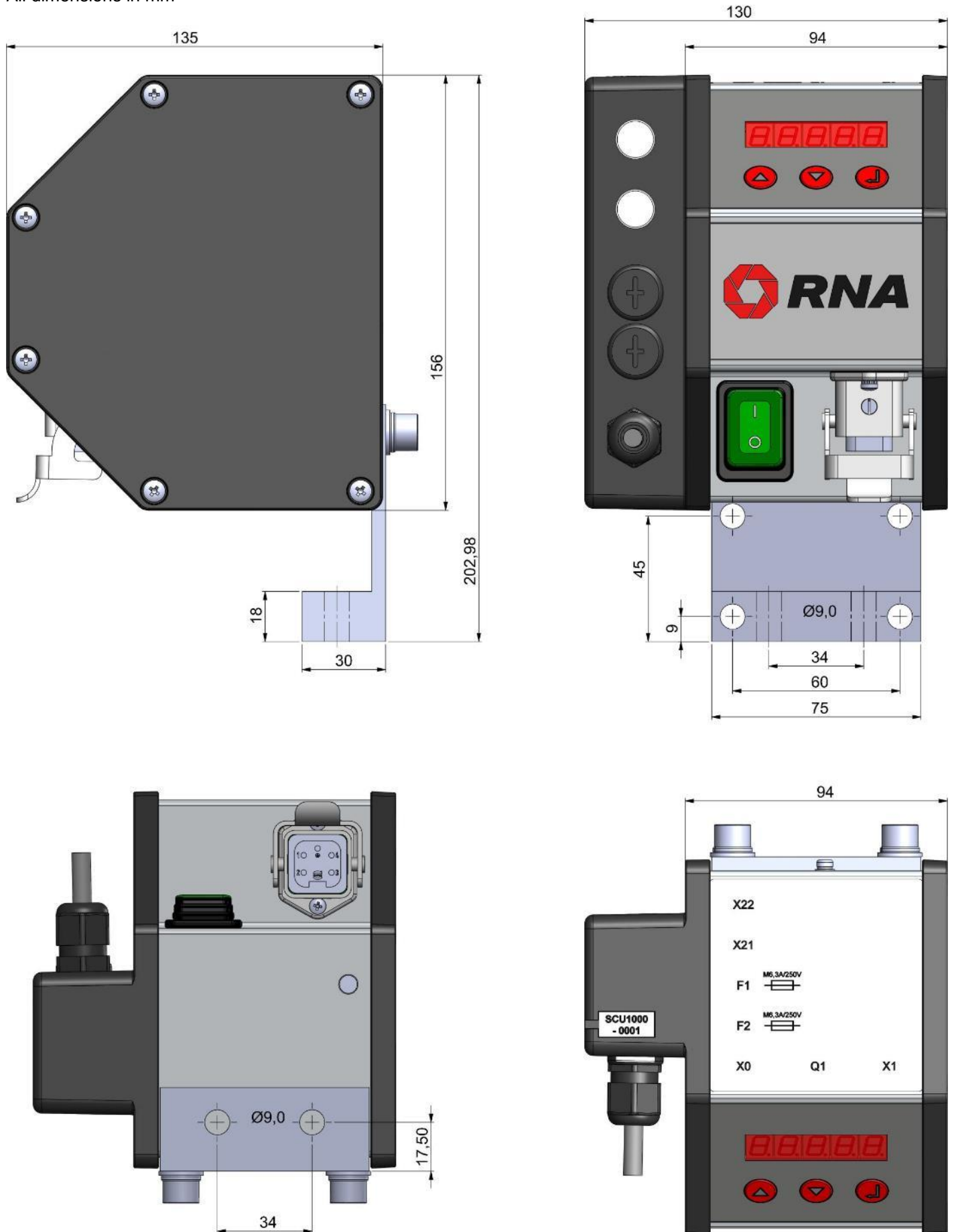



RNA Group

Headquarters

Manufacturing and Sales

Rhein-Nadel Automation GmbH

Reichsweg 19-23

D-52068 Aachen

Phone: +49 (0) 241-5109-0

Fax: +49 (0) 241-5109-219

E-mail: vertrieb@RNA.de

www.RNA.de

Further RNA group companies:



Manufacturing and Sales

Focus: Pharmaceutical Industry

PSA Zuführtechnik GmbH

Dr.-Jakob-Berlinger-Weg 1

D-74523 Schwäbisch Hall

Phone: +49 (0) 791 9460098-0

Fax: +49 (0) 791 9460098-29

E-mail: info@psa-zt.de

www.psa-zt.de



Manufacturing and Sales

RNA Automation Ltd.

Unit C

Castle Bromwich Business Park

Tameside Drive

Birmingham B35 7AG

United Kingdom

Phone: +44 (0) 121 749-2566

Fax: +44 (0) 121 749-6217

E-mail: RNA@RNA-uk.com

www.rnaautomation.com



Manufacturing and Sales

HSH Handling Systems AG

Wangenstr. 96

CH-3360 Herzogenbuchsee

Switzerland

Phone: +41 (0) 62 956 10-00

Fax: +41 (0) 62 956 10-10

E-mail: info@handling-systems.ch

www.handling-systems.ch



Manufacturing and Sales

Pol. Ind. Famades c/Energia 23

E-08940 Cornellà de Llobregat (Barcelona)

Spain

Phone: +34 (0)93 377-7300

Fax: +34 (0)93 377-6752

E-mail: info@vibrant-RNA.com

www.vibrant-RNA.com

www.vibrant.es

*Further manufacturing sites
of the RNA Group*

Manufacturing

Lüdenscheid branch

Rhein-Nadel Automation GmbH

Nottebohmstraße 57

D-58511 Lüdenscheid

Phone: +49 (0) 2351 41744

Fax: +49 (0) 2351 45582

E-mail: werk.luedenscheid@RNA.de

Manufacturing

Ergolding branch

Rhein-Nadel Automation GmbH

Ahornstraße 122

D-84030 Ergolding

Phone: +49 (0) 871 72812

Fax: +49 (0) 871 77131

E-mail: werk.ergolding@RNA.de

Manufacturing

Remchingen branch

Rhein-Nadel Automation GmbH

Im Hölderle 3

D – 75196 Remchingen-Wilferdingen

Phone: +49 (0) 7232 - 7355 558

E-mail: werk.remchingen@RNA.de