

## Operating Instructions

### Controllers for Vibratory Drive Systems

ESR 2500

ESR 2800

# Table of Contents

1.	About this document .....	5
2.	Safety information .....	5
2.1.	Design of safety directives .....	5
2.2.	Fundamental safety directives.....	5
2.3.	Personnel .....	5
2.4.	Intended use .....	6
2.5.	Residual hazards .....	6
2.5.1.	Device .....	6
2.5.2.	Protection of the drive system .....	6
2.5.3.	Degree of protection - Protection of persons and equipment .....	7
3.	Product information .....	7
3.1.	Functional description .....	7
3.2.	Standard features.....	7
3.3.	Applied standards .....	8
4.	Installation and commissioning .....	8
4.1.	Sequence of operations for installation and commissioning.....	8
4.2.	Mechanical installation .....	9
4.3.	Electrical installation.....	9
4.4.	Commissioning.....	10
4.5.	Choice of the right current range.....	10
4.6.	Sensor connection.....	13
4.7.	Connection diagram .....	14
4.8.	Voltage change .....	15
5.	Operator panel and display of the controller.....	16
5.1.	Operator panel - Display .....	16
5.2.	Navigating through the menus .....	17
5.3.	Main menu .....	18
5.3.1.	The "Status" screen:.....	18
5.3.2.	The "Info" screen:.....	18
5.3.3.	The "Extended" screen:.....	19
5.3.4.	Summary of ESR 2500, ESR2800 main menu.....	19
6.	The set-up menu.....	19
6.1.	List of set-up menu items .....	19
6.1.1.	Accumulation checker (sensor inputs).....	20
6.1.2.	Ramps .....	20
6.1.3.	Display calibration .....	21
6.1.4.	Communication / connector XS3 .....	21
6.1.5.	Analogue speed input.....	22
6.1.6.	High / Low speed.....	22
6.1.7.	Multiple settings.....	22
6.1.8.	Active braking.....	22
6.1.9.	Changing the password.....	23
6.1.10.	Activation code .....	23
7.	Calibration menu .....	23
7.1.	List of calibration menu items.....	23
7.1.1.	Start calibration .....	23
7.1.2.	Fine tuning.....	23
7.1.3.	Current sensor configuration .....	23
7.1.4.	Set max. current.....	23
7.1.5.	Mode .....	24

7.1.6.	Changing the password.....	24
7.2.	Calibration process.....	24
8.	Memory Reset.....	28
9.	Technical data.....	29
9.1.	Accessories.....	29
10.	Alarm messages .....	30
10.1.	Alarm message and troubleshooting .....	30
10.1.1.	Short-circuit protection active .....	30
10.1.2.	Overload protection active.....	30
10.1.3.	No feeder or low current.....	31
10.1.4.	Frequency error.....	31
10.1.5.	Vibration restricted .....	31
10.1.6.	Resonance frequency not found.....	32
10.1.7.	Resonance maximum not found.....	32
10.1.8.	PWM measurement offset error .....	32
10.1.9.	Voltage measurement offset error .....	32
10.1.10.	Current measurement offset error .....	32
10.1.11.	Offset error refusing common mode, distance measurement.....	32
10.1.12.	Magnet core saturation not found.....	33
11.	General errors .....	33



## Declaration of Conformity

According to the Low-Voltage Directive 2014/35/EU  
and Electromagnetic Compatibility Directive 2014/30/EU

We hereby declare that the product meets the following requirements:

Low-Voltage Directive 2014/35/EC  
Electromagnetic Compatibility Directive 2014/30/EU

Applied harmonised standards:           DIN EN 60204 T1  
  EN 61439-1

Remarks:

Rhein-Nadel-Automation  
-----

Managing Director  
Dr. Tobias Hensen



# 1. About this document



## Attention

Read this document carefully and observe the safety directives before commencing any work.

The information given in this document reflects the following version:

Product	from software version	Date
ESR2500	V1.2.7	2019-03-01
ESR2800	V1.2.7	2019-03-01

After power ON the version and serial number of the device are shown briefly.

## Document description:

This document provides assistance in choosing your product. You will also find information on mechanical and electrical installation, operation, product extensions and accessories.

Non-observance may cause trouble with the product or the environment, reduce the product lifetime or lead to other damage.

# 2. Safety information

## 2.1. Design of safety directives



## Notice

This notice identifies useful tips for use of the controller.



## Attention!

This symbol identifies hazardous situations.

Non-observance of such warnings may cause irreversible injury or even death!

## 2.2. Fundamental safety directives

Non-observance of the following fundamental safety measures and directives may lead to severe injury and damage to property!

Meeting the requirements given in the related documentation is a precondition for safe and trouble-free operation and for achieving the product properties specified. Further additional safety directives in the other sections must be observed as well.

## 2.3. Personnel



## Attention!

Any work on electrical equipment of the machine/system shall be carried out exclusively by a professional electrician, or by instructed persons working under the direction and supervision of a professional electrician, according to electrotechnical rules.

Only qualified professionals are allowed to work on or with the product. IEC 60364 or CENELEC HD 384 define the qualification of these persons:

- They are familiar with set-up, installation, commissioning and operation of the product.
- They possess the qualification required for performance of their work.
- They know all regulations for the prevention of accidents, directives and laws applicable to set-up, installation and commissioning on site, and they are able to apply the same.
- They have knowledge and skills of First Aid.

## 2.4. Intended use

Please observe the following directives for intended use of the controllers:

- The devices herein described must only be stored, fitted and operated under the conditions specified in this documentation.
- Here you are not concerned with domestic devices! They are solely intended to be used as components for commercial or professional applications pursuant to EN 61000-3-2.
- They satisfy the protection requirements of 2014/35/EU: Low Voltage Directive.
- They do not constitute a machine as defined by 2006/42/EU: Machinery Directive.
- A machine comprising the product must not be commissioned or put into operation for the intended use until it has been declared to be in conformity with the EC Directive 2006/42/EU: Machinery Directive; Observe EN 60204-1.
- Commissioning or starting operation for the intended use is only permitted in compliance with the EMC Directive 2014/30/EU.
- Use of the product in living areas may lead to EMC disturbance. The user is responsible for taking interference suppression measures.
- They are optimised for operation of RNA bowl feeders and linear feeders. Observe the limits indicated in the technical specification.

### Attention!



- Prior to start-up make sure that the protective earth conductor is connected and in proper condition. Make the PE conductor test with approved test devices only.
- Never start up despite detected damage.
- Do not make any technical modifications to the device, except as described in this document.
- Never start up in an incompletely installed state.
- Never operate the device without the required guards in place.
- Connect, disconnect or change any electrical connections only in the absence of voltage.

## 2.5. Residual hazards

Residual hazards may remain even if all directives have been observed and protective measures taken. Such residual hazards must be considered by the user in the risk assessment of his machine/equipment. Non-observance may lead to severe injury and damage to property!

### 2.5.1. Device

Pay attention to the warning signs fitted to the device!

Symbol	Description
	<b>Hazardous voltage:</b> Prior to commencing any work on the product check for absence of voltage on all power connections.
	<b>Caution - leakage current:</b> Make fixed installation and PE connection according to EN 60204-1!

### Attention



Before opening the controller, pull the mains plug and wait for the periods shown below, allowing the DC link circuit capacitors to discharge down to a safe voltage level.

#### Discharge period:

**ESR 2500**

**10 minutes**

**ESR 2800**

**15 minutes**

### 2.5.2. Protection of the drive system

Certain device parameter settings may cause overheating of the connected drive magnet, e.g., due to prolonged operation with an incorrectly set current range or maximum speed.

### 2.5.3. Degree of protection - Protection of persons and equipment

- All specifications relate to installed condition ready for operation.
- All slots not used must be closed by protection caps or dummy plugs in order not to reduce the protection against accidental contact.

## 3. Product information

### 3.1. Functional description

This fully automatic controller has been developed specifically to operate RNA bowl feeders or linear feeders with a high feed rate.

The intelligent controller continuously monitors the mechanical conveyor movement and uses this signal for active control of the vibration amplitude and thus the feed rate. This makes sure that the set feed rate is maintained irrespective of conveyor load, ambient temperature, supply voltage and supply frequency, etc.

The drive frequency is automatically controlled in a PLL circuit so that the feeder is run under optimum conditions at all times, i.e. exactly at the resonance frequency.

The controller adapts to the connected feeder by means of an automatic calibration sequence which largely eliminates the often laborious mechanical adaptation to the feeder.

These controllers allow vibrating motors to be operated at different mains frequencies without the need for changing the magnets or re-adjusting the feeder mechanically.

The controller is self-protected which makes sure that neither the drive magnets nor other components will be overloaded. The parameters of all mechanical and electrical components are permanently monitored. In case of significant deviations the monitoring function will output alarm messages before serious consequences can occur, i.e., it identifies a defective spring or loose nut before further damage occurs.

This controller has two 24V DC sensor amplifiers.

Moreover, there are two optocouplers and a relay output for status messages as well as an external enabling input of 24 V DC for remote control.

### 3.2. Standard features

- Dynamic electronic protection covering output short-circuits and output overloads.
- Active protection of magnets and motor.
- Permanently controlled speed which ensures stable running and repeatable speed setting.
- Low maintenance of the drive system.
  - The automatic frequency adjustment to the changes in drive characteristics reduces the need for frequent fine tuning of the drive springs.
- Reduced power consumption (approx. 50 %).
  - Motor requires less power as it runs in the resonance range.
- Flexible choice of frequency (25-150 Hz).
  - Drive frequency can be perfectly fine-tuned for a specific application, irrespective of the mains frequency.
- Not affected by mains fluctuations (voltage / frequency).
- Control over the entire feed system.
- 2 sensor amplifiers.
  - Two independent 24V DC sensor inputs for monitoring the feeder (accumulation check).
- Speed can be set by analogue setpoint entry.
- Communication
  - Electrically isolated 24V input for start/stop by external signal.
  - Readiness message (optocoupler, 24VDC, 20mA)
  - Active message (optocoupler, 24VDC, 20mA)
  - Active message via relay contact. 250VAC, 1A
- Firmware upgrade via USB port.
- Immediate stop function by active brake monitor.

- This optional feature stops the motor immediately in response to a stop command. This prevents a 'stop delay' and slow stoppage of the vibrating motor. This option is particularly useful where counters are involved, i.e., where an exact number of parts is to be counted without excess parts dropping off the feeder when the right number of parts is reached.
- Multiple calibration
- One device can be calibrated for up to 11 different motors.
- Electrically isolated 24V input for speed switching.

### 3.3. Applied standards

#### EC conformity

The controller is compliant with the following standards:

**EC EMC Directive 2014/30/EU**  
**EC Low-Voltage Directive 2014/35/EU**

Applied harmonised standards:

**DIN EN 60204, part 1**  
**EN 61439-1**

## 4. Installation and commissioning

This chapter deals with the mechanical and electrical installation of the controller.

The controller is designed for quick and easy installation by following the sequence of operations below.

### 4.1. Sequence of operations for installation and commissioning



#### Attention

Read the safety instructions in Chapter 2 prior to installation of the device.

#### Mechanical installation

- Mechanical installation

#### Electrical installation

- Connection to supply mains and protective earthing
- Load connection
- Control connection

#### Commissioning

- Calibration
- Programming

## 4.2. Mechanical installation

### Planning the place of installation:

Choose the best possible position taking the following into consideration:

- Ambient temperature
- Low-vibration mounting
- Operator access to controller
- Controller location near the vibrating motor
- Cable routing

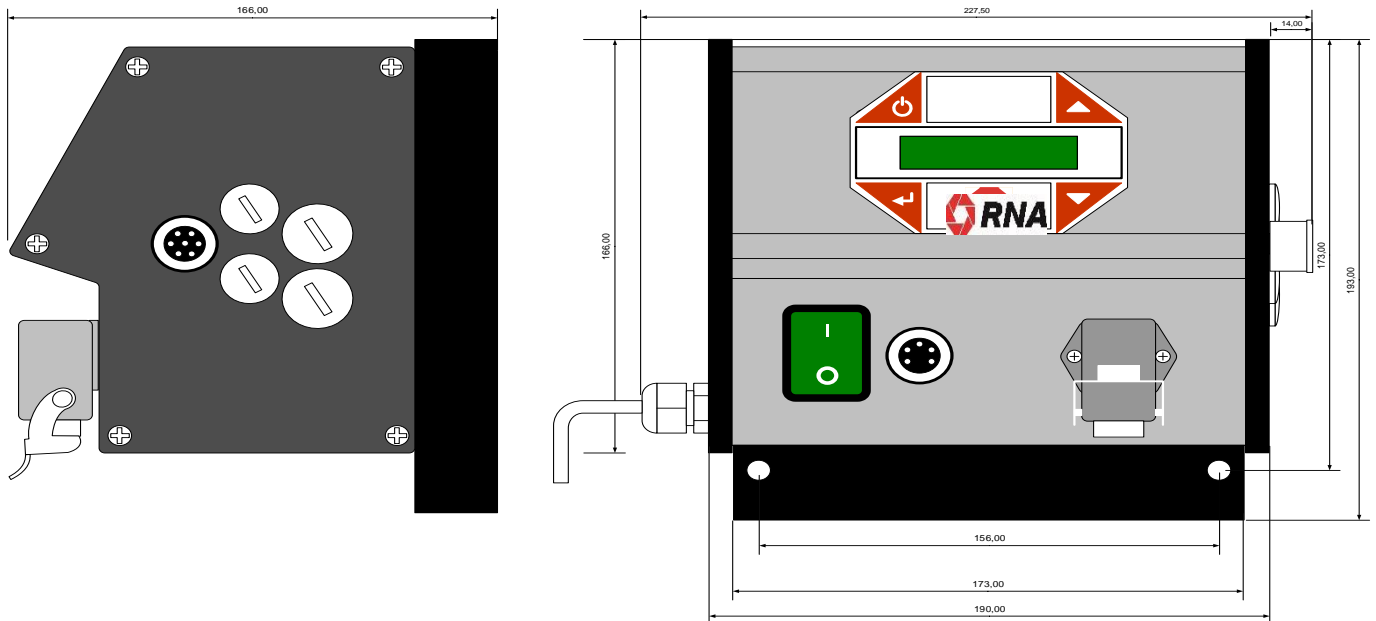

### Physical dimensions

Fix the ESR2500 - 2800 controller in place by inserting two M8x40mm screws through the two holes in the heat sink beneath the housing.

You can fix the device either directly to the feeder base plate or to the base frame of the machine.

A controller fitted directly to the feeder is exposed to strong vibration which may shorten its lifetime. It is highly recommendable, therefore, to mount the controller on a non-vibrating, mechanically rigid structure such as the base frame of a machine.

## 4.3. Electrical installation

### Fuses

The device is internally protected by a 4A 5x20mm time-lag fuse in the mains supply line.

Mains supply must be protected by overload protection with C 16A fusing.

### Earthing and supply mains



#### Notice

Check that supply voltage is in accordance with the data on the device rating plate.  
Check if controller setting has been changed to another supply voltage or magnet voltage.

**The ESR2500 / 2800 controllers are devices of protection class 1 which have to be connected to earth according to regulations.**



#### Attention

The cable connecting the controller with the vibratory feeder must be shielded and both ends of the shield connected to protective earth.

The maximum admissible cable length is 3 m.

---

**Attention**

Before you connect the controller to power supply and switch it on, it is mandatory to check the following:



- Is the controller in a good, safe operating state and closed with all screws tightened?
  - Are the connectors screwed in place/locked?
  - Are all cables and glands in proper condition?
  - Is operation for the INTENDED USE made sure?
  - Does the supply voltage specified on the controller match the local supply voltage?
- 

Do not start up the controller unless you can answer a clear YES to all the above questions.

---

**Attention**

Before starting operation after maintenance work or after controller replacement, set the output power on the controller to minimum before switching on. Check if the system works properly as you increase the output power.

---



#### 4.4. Commissioning

To prevent mechanical and/or electrical damage to the controller or connected devices, strictly observe all parameters specified under item 4.3. If you do not find your specific type in the table of drive units please contact Rhein Nadel Automation. We will be happy to advise you.

---

**Attention**

In order to ensure smooth and stable operation of the drive unit it is necessary to have a well-tuned drive system. Please also see the operating instructions of the feeder connected.

---



#### 4.5. Choice of the right current range

In order to achieve the optimum feeding performance the current range of the controller must be selected to suit the maximum load current of the vibrating motor according to Table 1 current setting of S301.

For information on the maximum current for the feeders please refer to the rating plate on the feeder motor and to Tables 2 and 3.

Current setpoint	2500	2800
100%	5.53 A*	9.00 A*
50%	2.75 A	4.50 A
33%	1.83 A	3.00 A
25%	1.37 A	2.25 A

Table 1 Connection table for max. current setpoint of S301

Always choose the lowest possible current range.

Example for ESR2500: The current input of the feeder is 2.5 A; use the 2.75 A current setpoint.

---

**Notice**

Set the correct current range also in the controller parameters.  
(See under 7.1.3.)

---



For setting the correct current range you must open the controller. For this be sure to observe the safety instructions in Chapter 2.

---

**Attention!**

Any work on electrical equipment of the machine/system shall be carried out exclusively by a professional electrician, or by instructed persons working under the direction and supervision of a professional electrician, according to electrotechnical rules.

---



# Wiring diagram/installation instructions

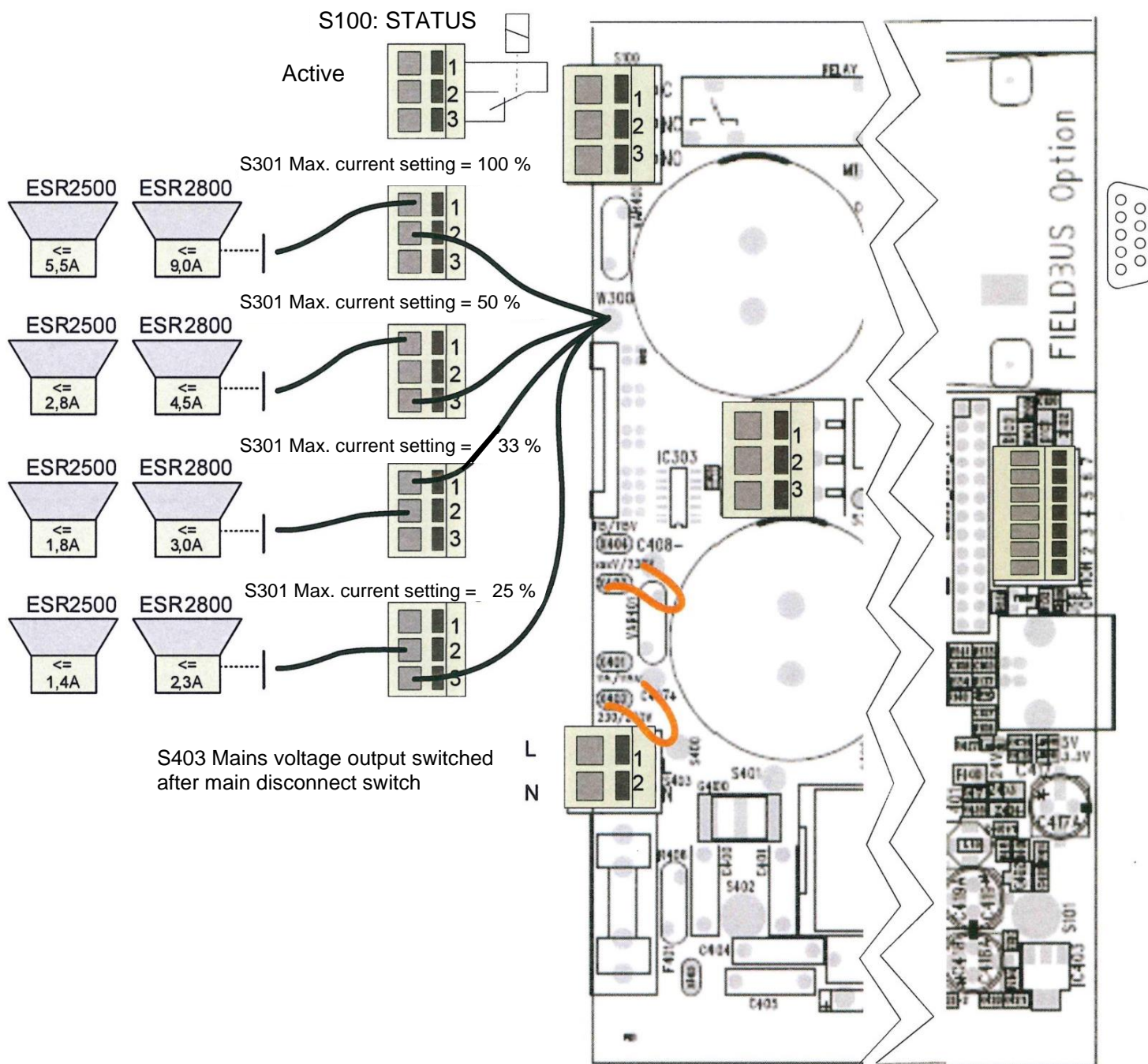

## Attention

Before opening the controller, pull the mains plug and wait for the periods shown below, allowing the DC link circuit capacitors to discharge down to a safe voltage level.

### Discharge period:

<b>ESR 2500</b>	<b>10 minutes</b>
<b>ESR 2800</b>	<b>15 minutes</b>



Achtung

<b>Motor type Bowl feeder</b>	<b>Max. current [A<sub>eff</sub>]</b>	<b>Max. coil gap [mm]</b>	<b>Frequency range</b>	<b>Magnet colour</b>
SRC - N 160 - 2	0.6	0.5	90...120 Hz	Black
SRC - N 200 - 2	1.2	0.5	90...120 Hz	Black
SRC - B 200 - 2	1.2	0.5	90...120 Hz	Black
SRC - N 250 - 2	2.6	1.2	90...120 Hz	Black
SRC - B 250 - 2	2.8	1.2	90...120 Hz	Black
SRC - N 400 - 1	3.8	2.8	45...60 Hz	Red
SRC - N 400 - 2	4.3	1.2	90...120 Hz	Black
SRHL - 400 - 1	5.7	2.8	45...60 Hz	Red
SRHL - 400 - 2	5.3	1.5	90...120 Hz	Black
SRC - N 630 - 1	5	2.8	45...60 Hz	Red
SRC - N 800 - 1	8.5	2.8	45...60 Hz	Red

Table 2 - RNA bowl feeders

<b>Motor type of linear feeder</b>	<b>Max. current [A<sub>eff</sub>]</b>	<b>Max. coil gap [mm]</b>	<b>Frequency range</b>	<b>Magnet colour</b>
SLL 400	0.6	1	90...120 Hz	Black
SLL 800	1.4	3	45...60 Hz	Red
SLL 804 < 1600	1.4	3	45...60 Hz	Red
SLL 804 ≥ 1600	2.8	3	45...60 Hz	Red
SLF 1000-1000	2.8	2.5	45...60 Hz	Red
SLF 1000-1500	5.6	2.5	45...60 Hz	Red
GL 01	0.6	1.5	90...120 Hz	Black
GL 1	1.1	1.0	90...120 Hz	Black
SLK N6	1.4	2.5	45...60 Hz	Red
SLK N6 G	1.4	2.5	45...60 Hz	Red

Table 3 - RNA linear feeders

## 4.6. Sensor connection

### Sensor input and sensor connection

The controller has two sensor inputs which can be used for accumulation checking and/or level monitoring purposes. You can connect sensors of type NPN or PNP.

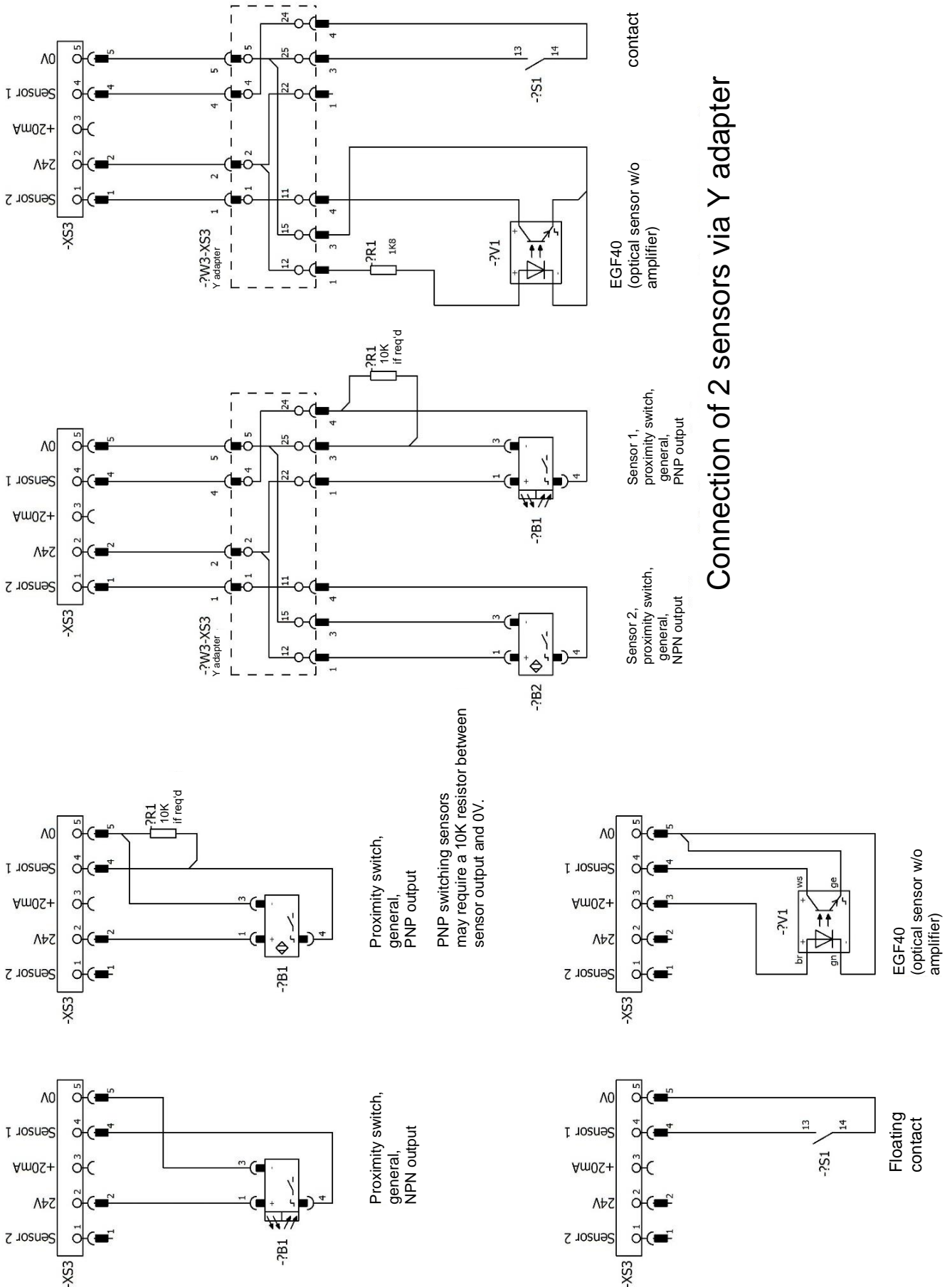

### Connection of 2 sensors via Y adapter

## 4.7. Connection diagram

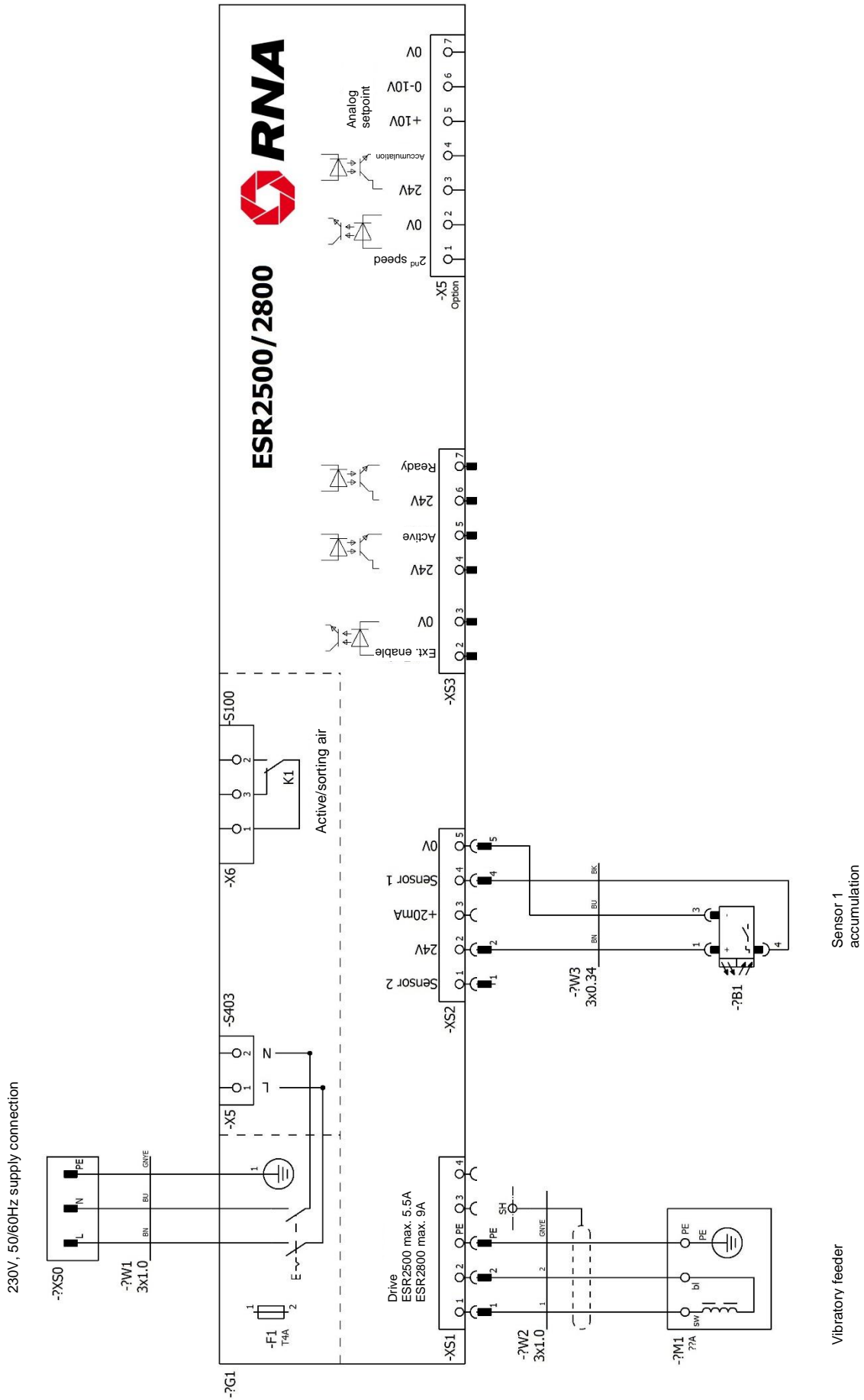

## 4.8. Voltage change

The ESR2500/2800 can be operated with various supply voltages and magnet voltages.

**For changing the voltage you must open the controller.**

**Therefore, be sure to observe the safety instructions and general warning notices in Chapter 2.**

You can set the controller to a mains supply voltage of 230V or 115V.

If set to a mains supply voltage of 230V the magnet voltage is always 200V.

If set to 115V mains supply you can choose a magnet voltage of 100V or 200V.

With 115V mains supply voltage it is recommended to choose a magnet voltage of 100V with corresponding magnets.

If you choose 200V magnet voltage with 115V mains supply, the mains supply voltage is doubled internally to achieve the 200V magnet voltage. This means that the current drawn from the 115V mains supply is also doubled. This is why this setting should be used in cases of emergency only.

How to set the controller to the different voltages is shown below.

### Wiring diagram/installation instructions

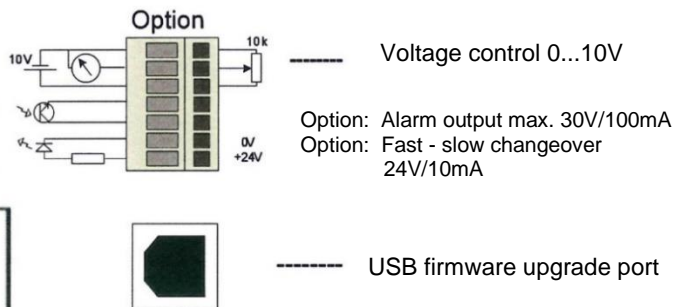
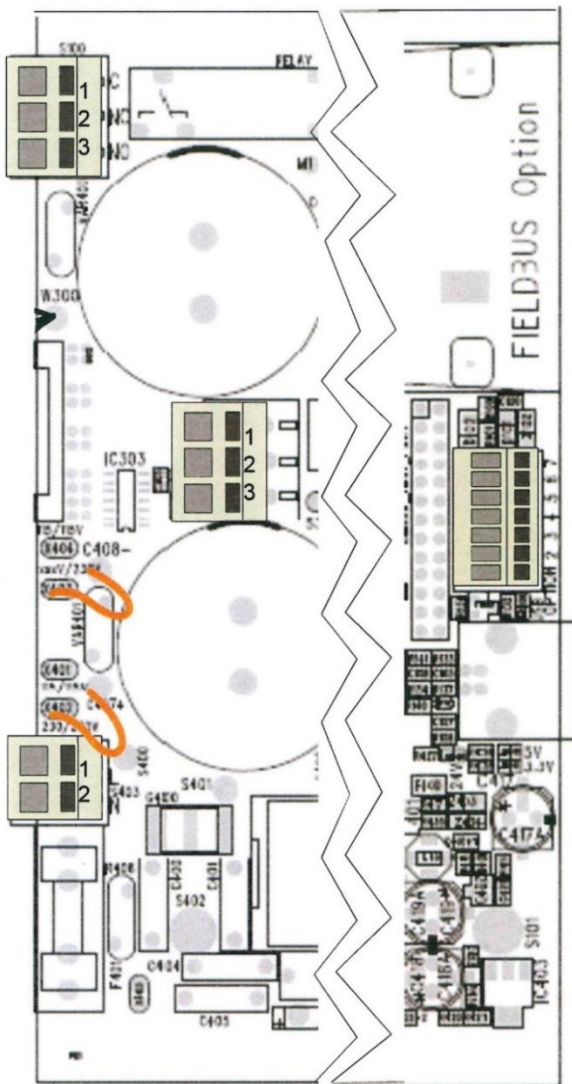

### Voltage change

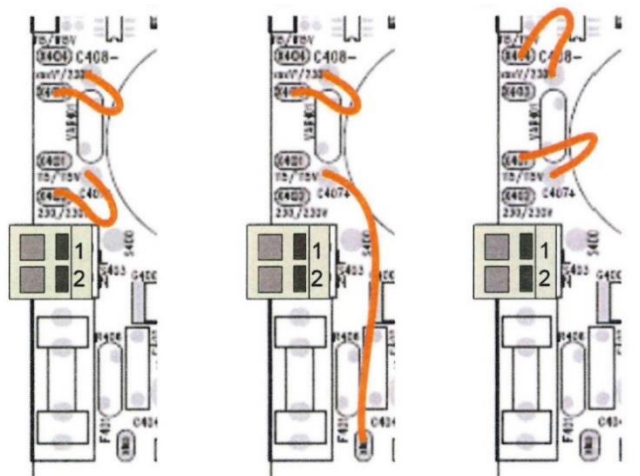

Standard setting  
Mains 230V  
Out 0...208V

Special setting  
Mains 115V  
Out 0...208V

Special setting  
Mains 115V  
Out 0...104V



**Warning !!!**  
If changed to 115V mains voltage do  
NOT connect to 230V mains.

## 5. Operator panel and display of the controller

### 5.1. Operator panel - Display

The operator panel of the ESR2500/2800 controller comprises four buttons and a 2x16 digit display.

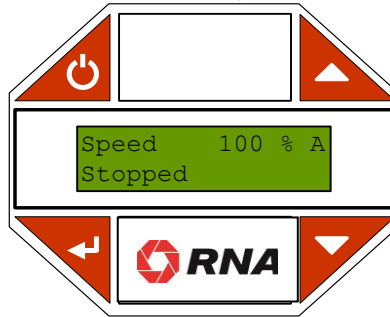

The functions assigned to the buttons are as follows:

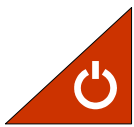

#### **ON / OFF**

is used to switch the connected feeder on and off.  
During calibration you can use this button also as Escape button to exit calibration.

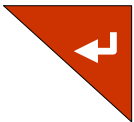

#### **Enter:**

is used to activate menus or parameter input and then to confirm the settings made.  
A parameter activated for setting purposes is shown in brackets; see below.  
“< XXXX >”

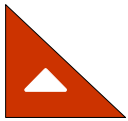

#### **Arrow buttons:**

Use these buttons to navigate through the menus and enter the parameters.



## 5.2. Navigating through the menus

There is 1 main menu and 2 submenus for operating the ESR2500/2800 controller. From the main menu you can enter the set-up menu or the calibration menu by entering the required password.

Use the arrow buttons for navigation through the menu screens. The menus are circular so that navigation beyond the last screen of a menu will take you back to the first screen and vice versa.

For changing the parameter of a given option, first go to the required option as described above. In order to enter the submenu of this option, press the Enter button.

In the submenu you can either set the parameter directly or go to a lower level of the submenu by repeating the steps described above. When you have reached the parameter you wish to set or change, press Enter to activate this parameter.

As soon as the parameter is active and can thus be changed, it is displayed in brackets.

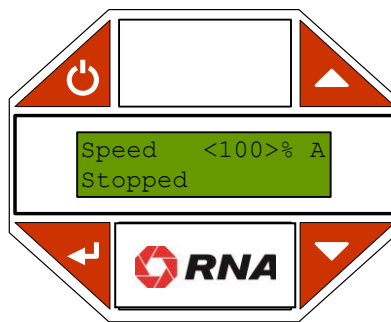

During navigation through the menus the parameters are shown without brackets.

For an active parameter the arrow buttons change their function, i.e., they no longer serve for navigation but now for setting of the active parameter.

When you have finished the parameter input, press Enter to acknowledge the new setting. The new parameter is saved.

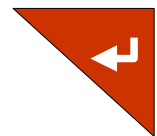
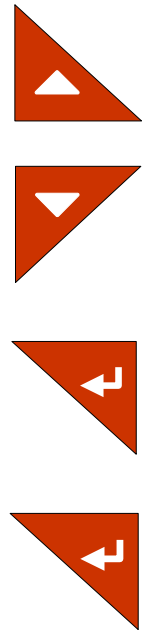

### 5.3. Main menu

The main menu comprises the "Status", "Info" and "Extended" screens.

#### 5.3.1. The "Status" screen:

The status screen shows the speed in percent and the current status of the controller.

The speed can be set from 0 to 100 % in Manual mode and from minimum to 100 % in Auto mode.



Speed 100% A  
Off

The set speed determines the vibration amplitude.

The controller operating mode is indicated to the right of the speed percentage by M for manual mode or A for automatic mode.

In Manual mode the speed is indicated in percent of the maximum output voltage. When the controller is calibrated and you switch the mode to Auto the speed is shown as a percentage of the maximum calibrated speed.

The second line shows the current controller status.



Speed 100% A  
Off

**Off:** The feeder was stopped by operation of the ON / OFF button.

**Ready:** The feeder is stopped by an external source, e.g., by an accumulation sensor, by the external enabling signal.

**On:** The feeder is in operation.

**Fault:** A fault exists.

Next to the status text the display shows the status of the external signals, starting with an asterisk "\*" followed by "1" if the controller is stopped by accumulation sensor 1, by "2" if the controller is stopped by accumulation sensor 2 or by "R" if the controller is stopped by the enabling signal input.



Speed 100% A  
Ready \*12R>AN

If the feeding speed is controlled by an external source the active source is indicated by > followed by a two-digit code.

The codes have the following meanings:

**"HS"** The speed is set to High.

**"LS"** The speed is set to Low.

**"ON"** Speed is controlled by the analogue input.

**"FB"** (optional)



Speed 100% A  
Ready >FB

#### 5.3.2. The "Info" screen:

The Info screen shows the measured values of output voltage, output current, output power and output frequency.



122V 0.91A  
86.3W 100.6Hz

### 5.3.3. The "Extended" screen:

From this screen you can access, with password, the set-up menu and the calibration menu. The default password is 1000 for the set-up menu and 2000 for the calibration menu.

### 5.3.4. Summary of ESR 2500, ESR2800 main menu

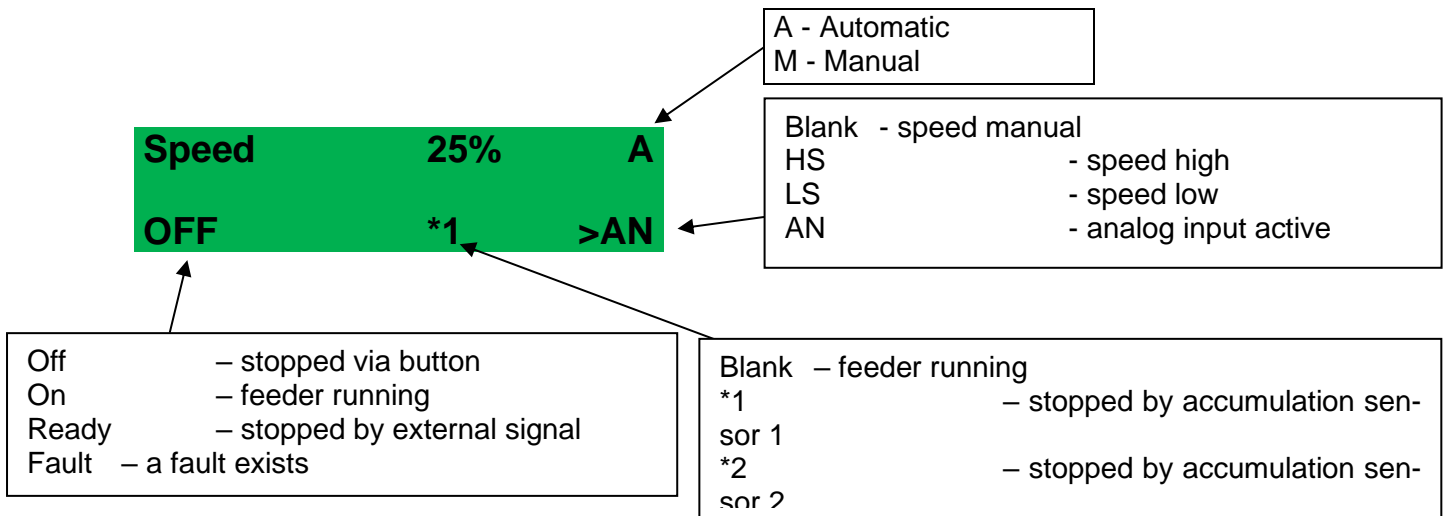

When the ESR2500 is switched on and stopped by accumulation or enabling signal the display changes from "On" to "Ready".

## 6. The set-up menu

You can open the set-up menu from the "Extended" screen of the main menu after entering the correct password.

### 6.1. List of set-up menu items

Some items of the "Set-up Menu" are optional (under preparation) and must be enabled by entering an activation code. Accordingly, access to the submenus is blocked until the required activation code has been entered. Blocked status of a menu is indicated by a small padlock at the bottom right of the display.



Hence, you can only enter the submenus that are activated. This makes navigation very easy because there is only a minimum of menus you have to navigate through.

The activation codes are unique for every single controller and can be acquired by indicating the requested option together with the serial number of the device. Some options require additional cables or hardware to be installed.

Upon input of the required code activating an optional menu, the entire tree of the submenu opens up giving you access to the parameter settings related to this option.



#### Notice

The parameters marked "Set-up specific" on the following pages will be stored separately for every calibration cycle.  
The parameters marked "General" apply to all calibrations.

For the digital inputs and outputs you can choose to configure the function as active at High (24V) or active at Low (0V).

### 6.1.1. Accumulation checker (sensor inputs)

You can connect up to two sensors to "sensor connection" XS2 for accumulation monitoring or level monitoring. See connection diagram in chapters 4.6 and 4.7. The signal may, e.g., come from a light barrier indicating whether an accumulation section is full or not. The accumulation check submenus make it possible to configure each sensor input separately.

The sensor input can be set at "inactive", "active at 24V" or "active at 0V". If the input is set at "inactive" the controller ignores the signal. If the input setting is "active at 24V" the feeder starts when the input is energized. As soon as the input is de-energized the feeder stops.

You can configure a start and stop delay for the sensor signal. The delay is the time in milliseconds between receipt of the sensor signal and the response.

You can choose the sensor types NPN or PNP.

In the "Accumulation link" submenu you can link the two sensor inputs "AND" "OR" and "XOR". If "AND" is set, both sensors must be active for the controller to stop the feeder. If "OR" is set, only one of the two sensors must be active for the controller to stop the feeder. If "XOR" is set the controller stops the feeder if the two sensors have different switching statuses.

Parameter description	Default setting	Range	Note
<b>Accumulation input 1</b>			
Stop / by	inactive	inactive / 0V / 24V	Set-up specific
Start delay	300 ms	0 - 60000 ms	Set-up specific
Stop delay	300 ms	0 - 60000 ms	Set-up specific
Sensor type	NPN	NPN / PNP	Set-up specific
<b>Accumulation input 2</b>			
Stop / start	inactive	inactive / 0V / 24V	Set-up specific
Start delay	300 ms	0 - 60000 ms	Set-up specific
Start delay	300 ms	0 - 60000 ms	Set-up specific
Sensor type	NPN	NPN / PNP	Set-up specific
Accumulation links	OR	OR / AND / XOR	Set-up specific

### 6.1.2. Ramps

The start ramp (soft start) makes sure that the output voltage slowly rises from 0 to the set value on every motor start. Too short settings of this time would lead to bumping of the vibratory feeder. Heavy feeders tend to overshoot if the voltage is increased too quickly.

Stopping of the vibratory feeder should not normally be delayed. In some cases, however, soft stoppage may be necessary to avoid misorientation of parts on the feeder stopping abruptly.

The time setpoint defines the soft start or stop duration. For example: With the Start ramp set at 1000 ms the feeder takes 1 second to build up vibration from 0 to 100 % or 500 ms to go from 0 to 50 % vibration.

Parameter description	Default setting	Range	Note
Soft start time	300 ms	50- 20000 ms	Set-up specific
Soft stop time	300 ms	50- 20000 ms	Set-up specific

### 6.1.3. Display calibration

You can configure the display on the controller as required.

In the Display Calibration menu item you can set the contrast/brightness. When lighting is set at "Normal" pressing of a button illuminates the display and after 10 seconds the light extinguishes again. When lighting is set to "On" the light remains on and if set to "Off" it remains off permanently.

You can also select the language. (See table)

Parameter description	Output parameter	Range	Note
Contrast	50%	0 - 100 %	General
Brightness	100%	0 - 100 %	General
Light control	Normal	Normal / fading / permanently On / permanently Off	General
Language	English	English / German / Danish / French	General

### 6.1.4. Communication / connector XS3

#### Enabling input

In the "Enabling" submenu you have the choice of setting the enabling input at "inactive", "active at 24V" or "active at 0V". If the input is set at "inactive" the controller ignores the signal. If the input setting is "active at 24V" a 24V enabling signal is released to the controller and the feeder starts. An on-delay and an off-delay of the enabling signal can be configured separately.

#### Active output

The "Active output" submenu is used for configuration of the output signal "active". You can set "Active On" or "Active Off". "Active On" means that the signal is switched on when the motor is running and off when it is stopped. The signal can also be delayed.

#### Active relay output

The "Active relay" submenu having similar functions as the "Active output" submenu is used for configuration of relay K1.

#### Ready output

The "Ready output" submenu is used for configuration of the Ready output signal. You can set "Active On" or "Active Off". Active On means that the signal is sent when the controller is energized by its power switch closed.

Parameter description	Output parameter	Range	Note
<b>Enabling input</b>			
Enabling =	Inactive	inactive / 0V / 24V	Set-up specific
Start enabling delay	300 ms	0 - 60000 ms	Set-up specific
Stop enabling delay	300 ms	0 - 60000 ms	Set-up specific
<b>Active output</b>			
Switched on =	OFF	inactive/active/off	Set-up specific
Stop delay	300 ms	0 - 60000 ms	Set-up specific
<b>Active relay output</b>			
Switched on =	OFF	inactive/active/off	Set-up specific
Stop delay	300 ms	0 - 60000 ms	Set-up specific
<b>Ready output</b>			
Ready =	OFF	inactive/active/off	Set-up specific

### 6.1.5. Analogue speed input

Speed setting (0-100%) can be controlled from an analogue source that can be set at 0-10V, 0-5V or 4-20mA. The connection is made to terminals located at the right-hand side, inside the controller, see chapters 4.7 and 4.8.

Parameter description	Output parameter	Range	Note
Analogue setting	Off	0-10V/0-5V / 4-20mA/ Off	Set-up specific

### 6.1.6. High / Low speed

The high/low input signal switches between the "high" and "low" speeds. The high speed is the currently set speed whilst the low speed is the percentage of the currently set speed.

You can configure the signal for high/low as follows: If the signal is set at "Off" the controller ignores the signal. If it is set at "active at 24V" the active signal sets the controller to high speed and the inactive signal sets the controller to low speed. The low speed is set at a percentage of the high speed. The delay periods serve to delay switching over to high or low speed.

Parameter description	Output parameter	Range	Note
High speed	Off	Off / 0V / 24V	Set-up specific
Low speed	25%	0-100%	Set-up specific
In high delay	300 ms	0 - 60000 ms	Set-up specific
In low delay	300 ms	0 - 60000 ms	Set-up specific

### 6.1.7. Multiple settings

In this menu you can select the parameters stored for up to 11 programmes.

The ESR2500 / 2800 controllers can store up to 11 different calibrations and settings. One controller can thus operate up to 11 different vibratory drives with 11 different set-ups (change pots).

All feeder-related calibration values and set-up parameters such as sensor type and functionality, ramps, etc. are stored specifically for each of the 11 calibration sets.

Only common parameters such as display settings and selected language, etc., are generally applied to all calibration sets.

In the detailed parameter description the parameters are identified as "Set-up specific" or "General".

Parameter description	Output parameter	Range	Note
Setting No.	Setting No. 1	1-11	General

### 6.1.8. Active braking

The active brake prevents a feeder vibration stop delay once the feeder is stopped. This option is particularly useful where counters are involved. Once the feeder has been stopped, feeding of further parts is to be avoided to the extent possible.

For this it is very important to set the right braking time.

If the braking time is too short the feeder does not come to a complete standstill and some vibration remains. If the braking time is too long the controller will "overbrake" the feeder causing new vibration to start after stoppage of the feeder. In both cases a slight "afterflow" of parts is to be expected.

If this option is activated the calibration process adjusts the braking times.

Parameter description	Output parameter	Range	Note
Active braking	Inactive	Active/inactive	
Brake setting	8	0-50	Set-up specific

### 6.1.9. Changing the password

In this submenu you can change the password for the extension menu. The default password is 1000. If you have forgotten the active password you can change it back to the default word by "Memory Reset".



#### Notice

Warning: This resets all parameters to the default values!

### 6.1.10. Activation code

Before you can use any one of the optional features it must be enabled by entering the activation code. Please contact our Customer Support for how to enable the optional features.

## 7. Calibration menu

You can open the calibration menu from the "Extended" screen of the main menu after entering the correct password.

### 7.1. List of calibration menu items

#### 7.1.1. Start calibration

Here you can start the calibration process itself. The calibration process takes several minutes.

Before starting calibration, make sure that the correct current range is set (hardware see chapter 4.5) and the current sensor is configured correctly (parameters see chapter 7.1.3).

For detailed description of the calibration process please refer to chapter 7.2.

#### 7.1.2. Fine tuning

Fine tuning of the minimum and maximum speeds is mandatory after successful calibration. Take great care in fine tuning because otherwise the controller cannot operate the vibrating drive in the proper way, see chapter 7.2.

After the speeds you can also adjust damping, if required.

The speed and damping values can also be adjusted later on without the need for re-calibration.

#### 7.1.3. Current sensor configuration

Before starting the calibration process make sure that the current sensor is correctly set.

There are 4 current ranges for the ESR2500 and ESR2800.

	25%	33%	50%	100%
ESR2500	Max. 1.37 A	Max. 1.83 A	Max. 2.75 A	Max. 5.5 A
ESR2800	Max. 2.25 A	Max. 3.0 A	Max. 4.5 A	Max. 9.0 A

Select the correct current range according to the vibrating drive, see also Tables 2 and 3, Chapter 4.5.

Always choose the lowest possible current range.

Example for ESR2500: The current input of the vibratory motor is 2.5 A; use the 2.75 A current setpoint.



#### Notice

The correct current range must also be set by hardware using wire jumpers in the controller; see chapter 4.5.

#### 7.1.4. Set max. current

The maximum load current of the vibratory motor is queried in the calibration menu also on every new calibration process and must be corrected if necessary.



#### Notice

This value is used to adjust the controller to the vibratory feeder connected.

### 7.1.5. Mode

The operating mode can be switched to Auto or Manual. You can select Auto mode only if the controller has been calibrated. If you select Manual mode the controller uses an adjustable frequency as fixed output frequency. This is why in Manual mode the automatic control of the vibration amplitude is lost. The manual frequency can be set in the submenu under "Manual frequency"

After calibration the controller automatically jumps to Auto mode.

### 7.1.6. Changing the password

Here you can change the password for the calibration menu. The default password is 2000. If you have forgotten the active password you can change it back to the default word by "Memory Reset".



#### Notice

Warning: This resets all parameters to the default values!

## 7.2. Calibration process

In order that the controller works perfectly with the vibratory feeder connected, it must be calibrated to suit the feeder. After calibration, the determined calibration parameters are saved and re-loaded automatically every time the controller is started.

Before calibration, set the correct current range; see chapters 4.5 and 7.1.3.

Re-calibration is required only if:

- The mechanical characteristics of the feeder have been changed, i.e., the number of springs, coil gap of magnets or the orienting tools.
- The electrical characteristics of the feeder have been changed, i.e., magnets replaced or air gap of magnets changed.

The calibration process takes place automatically.

For starting the calibration process first navigate from the main menu to the calibration menu.

Main menu	Geschw. 0 % Aus		Press button twice
Extended menu	Erweitert		
Enter password	Passwort Wählen 0000		Password 2000 for calibration menu
Start calibration	Kalibrierung anfangen		
Select no. of desired setting	Einstellung Nr Wählen <1>		1 - 11 Select using arrow but- tons

Set max. current	Max Strom = ( X,XX ) A		<b>Select using arrow buttons</b>  See tables 2 + 3
------------------	---------------------------	--	---

Calibration in progress	Kalibrierung Fängt an		<b>Progress bar in display</b>  <b>Abort by ON – OFF button</b>
-------------------------	--------------------------	--	---

Calibration completed	Kalibrierung gelungen		
-----------------------	--------------------------	--	--

Message	Feinjustierung Durchführen !!		<b>Proceed with fine tuning</b>
---------	----------------------------------	--	-------------------------------------

After successful calibration proceed with fine tuning.

Should one or several errors occur during the calibration process any such errors will be shown on the display. Press Enter to accept an error and the go to the next error, if any

	Kalibrierung anfangen		<b>Proceed with fine tuning</b>
--	--------------------------	---	-------------------------------------

Fine tuning	Feinjustierung		<b>Proceed with fine tuning</b>
-------------	----------------	--	-------------------------------------

### Fine tuning (Min. Or max. values in fine tuning)

Parameter description	Output parameter	Range	Type
Maximum speed	NA	1000-100,000	Set-up specific
Minimum speed	NA	1000-30,000	Set-up specific
Damping	50%	1-100%	Set-up specific

### Fine tuning of maximum speed

Here you set the maximum speed at which the feeder is to run. Place some parts into the bowl, start the feeder using the ON/OFF button and set the maximum speed using the arrow buttons.

When the feeder starts bumping, stop it immediately by pressing the ON/OFF button and reduce the speed or correct the mechanical adjustment.

When the required maximum speed is set:

**Press the Enter button with the feeder running to save the new maximum speed** or press Enter with the feeder stopped to return to the previous minimum speed.

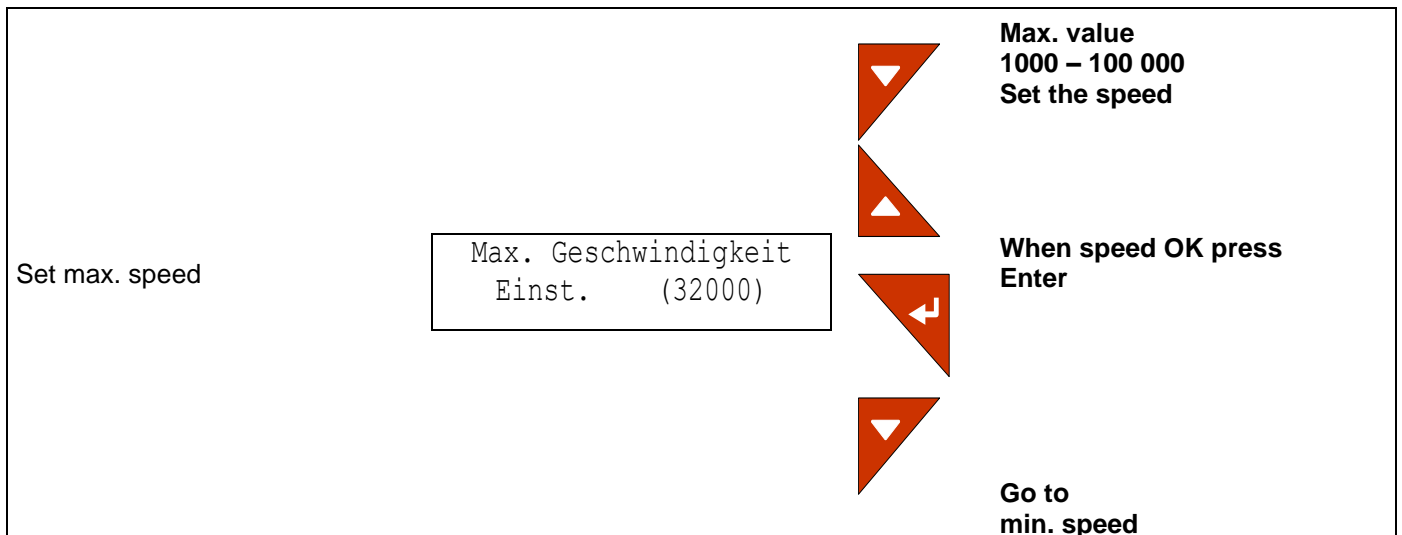
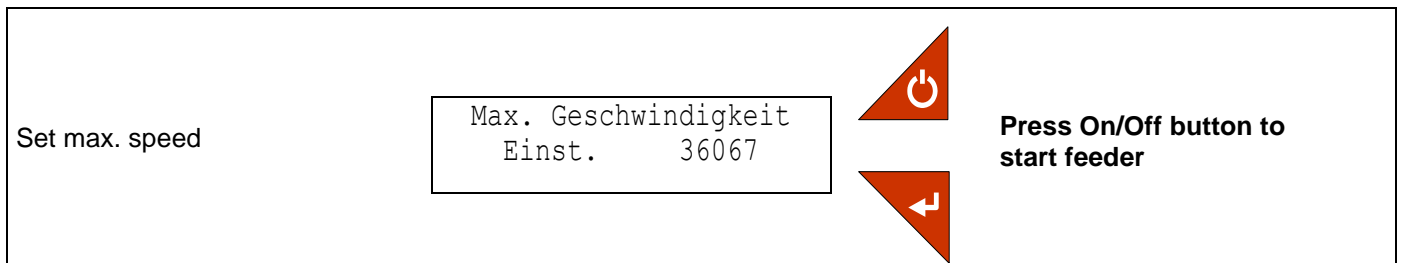

When setting the maximum speed make sure that the maximum permitted vibration amplitude of the feeder is not exceeded.

An excessive vibration amplitude poses the risk of breaking springs, tearing screws etc.

### Fine tuning of minimum speed

Here you set the minimum speed at which the feeder is to run.

Place some parts into the bowl, start the feeder using the ON/OFF button and set the minimum speed using the arrow buttons. The parts in the bowl must move slowly. It is particularly important to make sure that the feeder runs smoothly for at least 10 seconds.

When the required minimum speed is set:

**Press the Enter button with the feeder running to save the new minimum speed** or press Enter with the feeder stopped to return to the previous minimum speed.

### Notice





The controller can adjust the vibration amplitude and frequency only in the presence of a certain vibration. If the vibration level is too low the controller cannot operate the feeder in the resonance zone and the feeder stops vibrating. In this case increase the set value until an audible and visible vibration of the feeder is established. After that you can reduce this value again but take care that the vibration does not stop completely.

If you cannot hear or see the vibration during this set-up process, a stability bar on the display indicates how stably the feeder is running. Any change of the feeder frequency away from the resonance zone is indicated by the stability bar. If the bar starts flickering or if it indicates a frequency error of more than 2 bar points you should increase the speed setpoint until the display bar is stable again.

**Having set the speed, stop the vibrating drive using the ON/OFF button; the set values are now saved.**

Set min. speed





Min. Geschwindigkeit  
Einst. 3718

If feeder is off, press ON/OFF button to start it.

Set min. speed

Min. Geschwindigkeit  
Einst. (3000)

Min. value  
1000 – 30 000  
Set the speed

When speed OK – press Enter

Stop the feeder

Go to damping

### Set damping

Here you can set damping of vibration amplitude control. If the feeder overshoots on starting or if speed setpoint changes cause vibration amplitude fluctuations it is advisable to set the value a little higher. If such cases do not happen with your feeder but it responds slowly to load changes we would recommend to set the value a little lower.

In the majority of cases the default value of 50% will be fine.



Set damping

Dämpfung einstellen  
50 %



Set damping



Dämpfung einstellen  
( 60 % )

  



Set damping  
0 – 100%

Setting of damping finished

Dämpfung einstellen  
60 %

1 ←----- 2		<b>One level up</b>
------------	--	---------------------

Feinjustierung		<b>4x</b>
----------------	--	-----------

0 ←----- 1		<b>One level up</b>
------------	--	---------------------

This completes the calibration procedure.

## 8. Memory Reset



### Attention:

This resets all parameters to the default values!

### Resetting to default values

In order to reset the controller to the factory settings open the power switch to disconnect the supply voltage and wait for the display to darken. Now press and hold down the two "up" and "down" arrow buttons and then switch-on supply voltage again. When the display shows:

**Memory  
reset**

resetting to the default values is successfully completed.

## 9. Technical data

	ESR2500/110V	ESR2500/230V	ESR2800/110V	ESR2800/230V
Supply voltage	115Volt AC, 50/60Hz, +/-10%	230Volt AC, 50/60Hz, +/-10%	115Volt AC, 50/60Hz, +/-10%	230Volt AC, 50/60Hz, +/-10%
Output voltage	0-104 Veff or 0- 208 Veff	0-208 Veff	0-104 Veff or 0- 208 Veff	0-208 Veff
Max. working current (4 current ranges available)	5.5Aeff / 2.75Aeff / 1.83Aeff / 1.37Aeff		9.0Aeff / 4.5Aeff / 3.0Aeff / 2.25Aeff	
Min. working current	2 % of max. working current			
Output frequency	25-150 Hz mechanical vibrating frequency			
Internal fusing	5x20mm, 4A slow			
Soft start time, Soft stop time	0.05 to 20 seconds			
External setpoint	0-10Vdc / 0-5Vdc / 4-20mA			
Sensor inputs	2, adjustable for NPN or PNP sensors			
Remote control inputs ON/OFF	24VDC			
Remote control inputs SLOW/FAST	24VDC			
Sensor power supply	24VDC, max. 25 mA total			
Sensor delay ON	0.....60 sec.			
Sensor delay OFF	0.....60 sec.			
2 outputs	24VDC / 20mA optocoupler outputs			
1 output	Relay, floating changeover contact max. 250V / 8A			
USB Standard	1.1 (full speed)			
USB connector	USB type B "device plug"			
Operating temperature	0.... 40°C			
Degree of protection	IP54			
Leakage current	less than 2 mA			



### Notice

Supply voltage and load voltage must be set-up by hardware change in the controller; see chapter 4.5 and quick guide in the controller.

### 9.1. Accessories

Tag	Designation	Type	RNA article code
<b>XS1</b>	Load connector	5-pin (EMC)	31002329 (50Hz drive)
<b>XS1</b>	Load connector	5-pin (EMC)	31002325 (100 Hz drive)
<b>XS2</b>	Male connector	5-pole, straight	35051144
<b>XS2</b>	Male connector	5-pole, right-angled	35002546
<b>XS3</b>	Female connector	7-pole, straight	35051153
<b>XS3</b>	Female connector	7-pole, right-angled	35002545
<b>For XS2</b>	Y adapter	for connection of 2 sensors	39905940

## 10. Alarm messages

In case of errors or faults various alarms and other messages appear on the display. The alarm messages come up in an order of priority. If more than one alarm is active only the one of highest priority will appear. The operator must press the Enter button to reset the alarm.

Priority (Alarm No.)	Message text
1	Short-circuit protection active
2	Overload protection active
3	No feeder or low current
4	Frequency error
5	Vibration restricted
6	Resonance frequency not found
7	Resonance maximum not found
8	PWM measurement offset error
9	Voltage measurement offset error
10	Current measurement offset error
11	Offset error refusing common mode, distance measurement
12	Magnet core saturation not found

### 10.1. Alarm message and troubleshooting

#### 10.1.1. Short-circuit protection active

Short-circuit protection is activated when the current reaches a peak value exceeding 20 A. In this case the controller disconnects the output voltage immediately to protect the output stage against damage. The alarm message remains on the display until it is reset by Enter. The alarm comes up in response to a short circuit at the load output or if the current drawn by the connected feeder is much higher than the maximum load current.

Remedy:

1. Switch-off the feeder and check the cables and vibrating drive for short-circuits and other damage.
2. Make sure that the maximum current is set to the correct value; Tables 2 and 3.
3. Make sure that the current range (hardware) and the current sensor (parameter) are set correctly. See chapters 4.5 and 7.13.

#### 10.1.2. Overload protection active

This alarm comes up if the load current exceeds twice the value of the maximum r.m.s. current. In this case the controller disconnects the output voltage immediately to protect the output stage against overload. The alarm message remains on the display until it is reset by Enter.

Remedy:

1. Switch-off the feeder and check the cables and vibrating drive for damage.
2. Make sure that the maximum current is set to the correct value. (See tables 2 and 3.)
3. Make sure that the current range (hardware) and the current sensor (parameter) are set correctly. See chapters 4.5 and 7.13.
4. If items 1 to 3 are OK, try to increase the soft start time.

### 10.1.3. No feeder or low current

This alarm appears in case of cable break or if the current drawn by the connected feeder is very small related to the maximum current.

Remedy:

1. Switch-off the feeder and check the cables and vibrating drive for discontinuity and other damage.
2. Make sure that the maximum current is set to the correct value. (See tables 2 and 3.)
3. Make sure that the current range (hardware) and the current sensor (parameter) are set correctly. See chapters 4.5 and 7.13.
4. Power input to the vibratory motor is too low for the controller.

### 10.1.4. Frequency error

The resonance frequency of the feeder has reached one of the limits. This may be due to various reasons:

1. Insufficient minimum speed setpoint.

During set-up of the minimum speed the controller sets the limits of the admissible frequency range. This is why it is essential that the feeder runs in a stable manner and that it has done so for at least 10 seconds before you exit the calibration menu. The limit values are saved when you exit the menu. The controller can only control the vibration amplitude and frequency automatically if there is a certain degree of vibration. If the feeder speed during minimum speed calibration is so slow that the frequency gets unstable, the found frequency limits might be incorrect. The values of minimum speed and maximum speed should differ at least by the factor "4".

Remedy:

Re-set the minimum speed while making sure that feeder operation is stable before you exit the menu.

2. Very high load of heavy product. Accordingly, the frequency has dropped by more than 20 % due to the heavy load.

Remedy:

none In this case you can ignore the alarm. The feeder will continue running but the feed rate may possibly be somewhat reduced if the load is still increased and the maximum current setpoint of the controller is reached.

3. Broken or loose springs or spring bolts.

Remedy:

Check spring mounting, springs and spring bolts.

Replace as necessary and tighten at the specified torque.

### 10.1.5. Vibration restricted

This alarm appears if the controller cannot maintain the required speed (vibration amplitude) without overloading the oscillating magnets.

This alarm message appears if the feeder speed is less than half the set speed but the feeder draws the full current. This is not necessarily a malfunction; the cause may be excessive loading of the feeder with heavy product.

Other potential reasons why the feeder cannot vibrate freely may be a broken or loose spring, air gap of a magnet blocked by dirt or other mechanical causes.

This alarm message may also come up if a heavily loaded feeder is started very quickly. In this case the feeder takes a while to reach the required speed even though it draws the full current.

Remedy:

1. Reduce product load of the feeder.
2. Set the soft start and maybe the damping parameters to a higher value. This has no negative effect on starting because the product load is the limiting factor of the starting speed.
3. Check if the feeder can vibrate freely.
4. Check the springs. Replace the springs as necessary and re-tighten. Also clean the air gap of the magnets.
5. Check if there is any other mechanical cause at the feeder preventing free vibration.

#### 10.1.6. Resonance frequency not found

This error occurs during calibration if the controller cannot find the resonance frequency of the feeder.

Remedy:

1. Check that the feeder can vibrate freely and that it is empty.
2. Check the springs. Replace the springs as necessary and re-tighten. Also clean the air gap of the magnets and re-adjust.
3. Check current setpoint of the controller and re-set to suit the feeder.

Having checked the above items try to re-calibrate the feeder.

#### 10.1.7. Resonance maximum not found

This error occurs during calibration if the controller cannot perfectly adjust the frequency related to the feeder.

Remedy:

1. Check that the feeder can vibrate freely and that it is empty.
2. Check the springs. Replace the springs as necessary and re-tighten. Also clean the air gap of the magnets.
3. Check current setpoint of the controller and re-set to suit the feeder.

Having checked the above items try to re-calibrate the feeder.

#### 10.1.8. PWM measurement offset error

This is a self-diagnostic error which occurs only in connection with the calibration process, i.e., if errors in the modulation circuit are so severe that they cannot be compensated by the automatic offset adjustment.

Remedy:

1. Try to re-calibrate.
2. Please contact customer support.

#### 10.1.9. Voltage measurement offset error

This is a self-diagnostic error which occurs only in connection with the calibration process, i.e., if errors in the measuring circuits are so severe that they cannot be compensated by the automatic offset adjustment.

Remedy:

1. Perform a re-calibration procedure.
2. Please contact customer support.

#### 10.1.10. Current measurement offset error

This is a self-diagnostic error which occurs only in connection with the calibration process, i.e., if errors in the measuring circuits are so severe that they cannot be compensated by the automatic offset adjustment.

Remedy:

1. Try to re-calibrate.
2. Please contact customer support.

#### 10.1.11. Offset error refusing common mode, distance measurement

This is a self-diagnostic error which occurs only in connection with the calibration process, i.e., if errors in the measuring circuits are so severe that they cannot be compensated by the automatic offset adjustment.

Remedy:

1. Try to re-calibrate.
2. Please contact customer support.

### 10.1.12. Magnet core saturation not found

This is a self-diagnostic error which occurs only in connection with the calibration process. This error comes up if the controller cannot compensate the magnet core saturation related to the feeder.

Remedy:

1. Try to re-calibrate.
2. Make sure that the air gap of the magnets is correctly adjusted and not blocked by metal chips.
3. Make sure that magnets are firmly seated.

## 11. General errors

1. Controller does not start up.
2. Check if supply voltage is available and the power switch is closed. The power switch must show green light.
3. Power switch shows green light but the device still does not start.
4. Internal fuse F401 has tripped. Replace the fuse with a 5x20mm 4A time-lag fuse.



#### **Attention:**

Qualified personnel required.  
Observe safety instructions; see chapter 2.

---



#### **Attention:**

Before opening the controller, pull the mains plug and wait for the periods shown below, allowing the DC link circuit capacitors to discharge down to a safe voltage level.

#### **Discharge period:**

<b>ESR 2500</b>	<b>10 minutes</b>
<b>ESR 2800</b>	<b>15 minutes</b>

---

5. Device starts and display shows "Ready" but the feeder does not start.
  - 5.1 Make sure that the controller has been enabled, indeed by all external inputs. See Section 5.3 Main menu.
  - 5.2 Verify that the digital inputs not used have not been set to "active" in the set-up menu.
  - 5.3 Please contact customer support.



### Headquarters

Rhein-Nadel Automation GmbH  
Reichsweg 19-23  
D-52068 Aachen  
Phone: +49 (0)241-5109-0  
E-mail: [vertrieb@RNA.de](mailto:vertrieb@RNA.de)  
[www.RNA.de](http://www.RNA.de)

### Further RNA group companies:



PSA Zuführtechnik GmbH  
Steinackerstraße 7  
D-74549 Wolpertshausen  
Phone: +49 (0)7904-94336-0  
E-mail: [info@psa-zt.de](mailto:info@psa-zt.de)  
[www.psa-zt.de](http://www.psa-zt.de)



RNA Automation Ltd.  
Unit C Castle Bromwich Business Park  
Tameside Drive Birmingham B35 7AG  
Great Britain  
Phone: +44 (0)121-749-2566  
E-Mail: [sales@rnaautomation.com](mailto:sales@rnaautomation.com)  
[www.rnaautomation.com](http://www.rnaautomation.com)



HSH Handling Systems AG  
Wangenstraße 96  
3360 Herzogenbuchsee  
Switzerland  
Phone: +41 (0)62-956 10-00  
E-mail: [info@handling-systems.ch](mailto:info@handling-systems.ch)  
[www.handling-systems.ch](http://www.handling-systems.ch)



RNA Vibrant S.A.  
Carrer de l'Energia  
08940 Cornellà de Llobregat (Barcelona)  
Spain  
Phone: +34 (0)93-377-7300  
E-mail: [info@vibrant-RNA.com](mailto:info@vibrant-RNA.com)  
[www.vibrant-RNA.com](http://www.vibrant-RNA.com)



RNA Digital Solutions GmbH  
Reichsweg 19-23  
D-52068 Aachen  
Phone: +49 (0)1515-99 28 255  
E-mail: [kontakt@rnadigital.de](mailto:kontakt@rnadigital.de)  
[www.designforfeeding.com](http://www.designforfeeding.com)  
[www.rnadigital.de](http://www.rnadigital.de)

### Further manufacturing sites of the RNA Group

#### Lüdenscheid site

Rhein-Nadel Automation GmbH  
Nottebohmstraße 57  
D-58511 Lüdenscheid  
Phone: +49 (0) 2351 -41744  
E-mail: [werk.luedenscheid@RNA.de](mailto:werk.luedenscheid@RNA.de)

#### Ergolding site

Rhein-Nadel Automation GmbH  
Ahornstraße 122  
D-84030 Ergolding  
Phone: +49 (0) 871 -72812  
E-mail: [werk.ergolding@RNA.de](mailto:werk.ergolding@RNA.de)

#### Remchingen site

Rhein-Nadel Automation GmbH  
Im Hölderle 3  
D-75196 Remchingen-Wilferdingen  
Phone: +49 (0)7232-7355-558  
E-mail: [werk.remchingen@RNA.de](mailto:werk.remchingen@RNA.de)