

Operating Instructions for Linear Feeders

SLC 500 – 200

SLC 500 – 300

SLC 500 – 400

Table of Contents

1.	Technical data.....	4
2.	Safety Information	6
2.1.	Applicable directives and standards	7
3.	Design and functional description of linear feeder.....	7
4.	Shipment and installation	8
4.1.	Shipping and handling.....	8
4.2.	Installation	9
5.	Commissioning.....	10
5.1.	Tuning	10
5.1.1.	Mechanical tuning procedure for use with compact control unit	11
5.1.2.	Tuning procedure for use with frequency-controlled control unit	12
5.2.	Changing the spring configuration.....	13
5.3.	Adjusting the desired feeding behaviour / synchronism of the linear feed rail	14
5.4.	Spring angle adjustment.....	15
5.5.	Adjusting the magnet air gap.....	15
6.	Feed rail design rules	15
7.	Maintenance.....	16
8.	Spare parts and customer service.....	16
9.	What if... (Advice on troubleshooting)	17



Declaration of Incorporation

according to Machinery Directive 2006/42/EC

We,
Company

Rhein-Nadel Automation GmbH
Reichsweg 19-23
52068 Aachen
Germany

herewith declare under our sole responsibility that with regard to the following product:

Machine designation: (function)	Linear Feeders
Type designation:	SL(...) GL(...)
Serial number	10865660 0001 2500000 0001

all relevant essential safety and health requirements of Directive 2006/42/EC have been fulfilled up to the battery limits.

The product to which this declaration refers is furthermore in conformity with following directives and standards or other regulations:

2006/42/EC	Machinery		
2006/95/EC	Low Voltage		
2014/30/EU	Electromagnetic Compatibility		
EN 614-1	2006+A1:2009	EN ISO 13857	2008
EN 619	2002+A1:2010	EN ISO 14120	2015
EN 620	2002+A1:2010	EN 60204-1	2006
EN ISO	12100	2010	

The relevant technical documentation has been compiled in accordance with Annex VII B of the Machinery Directive and on request, such documentation will be transmitted to the competent authorities in hard copy.

Nico Altmeyer, Rhein-Nadel Automation GmbH, Reichsweg 19-23, 52068 Aachen
(Name and address of person authorised to compile the relevant technical documentation)

Notice: This machine must not be put into service until the complete system into which it will be incorporated has been declared to be in conformance with the provisions of the Directive.

Signatory information

Name: Dr. Hensen

Given name: Tobias

Function: Managing Director

Germany
Aachen,

Place and date

Signature

1. Technical data



Notice

All linear feeders listed in this table shall be operated only in conjunction with an RNA controller and with a mains voltage of 230 V / 50 Hz. For special voltages and frequencies please refer to the separate data sheet.

Linear feeder, type SLC 500

Linear Feeder Type	SLC 500-200	SLC 500-300	SLC 500-400
Dimensions L x W x H (mm)	500 x 370 x 148	500 x 470 x 148	500 x 570 x 148
Weight	40 kg	40 kg	50 kg
Degree of protection	IP 54	IP 54	IP 54
Connecting cable length (m)	2	2	2
Power input ¹⁾ (VA)	502	502	502
Current ¹⁾ (A)	2.52	2.52	2.52
Nominal magnet voltage ¹⁾ / frequency (V / Hz)	200 / 50	200 / 50	200 / 50
Number of magnets	2	2	2
Magnet type	YZAW 080	YZAW 080	YZAW 080
Article number	35000763	35000763	35000763
Magnet colour	Red		
Air gap (mm)	3.0	3.0	3.0
Vibration frequency (Hz)	50 Hz		
Number of spring packs	2	2	2
Standard spring set	4 x 2.5	4 x 2.5	6 x 2.5
Total number of springs	8 x 3.5	8 x 3.5	12 x 3.5
Spring dimensions (mm)	108 (90) x 55 (25)		
Length (borehole gauge) x width	108 (90) x 55 (25)		
Spring thickness (mm)	2.5 + 3.5	2.5 + 3.5	2.5 + 3.5
Property classes of spring fastening bolts	8.8	8.8	8.8
Tightening torque of spring fastening bolts	30 Nm	30 Nm	30 Nm
Tightening torque of lateral spring fastening bolts	80 Nm	80 Nm	80 Nm
Max. weight of linear rail, depending on mass moment of inertia and desired feeder speed	40 kg	50 kg	60 kg
Maximum rail length (mm)	1,000	1,000	1,000
Max. useful weight of the linear feeder unit, depending on mass moment of inertia and desired feeder speed	100 kg	100 kg	100 kg

¹⁾ For special connections (voltage / frequency) see rating plate on the magnet

Pin assignment

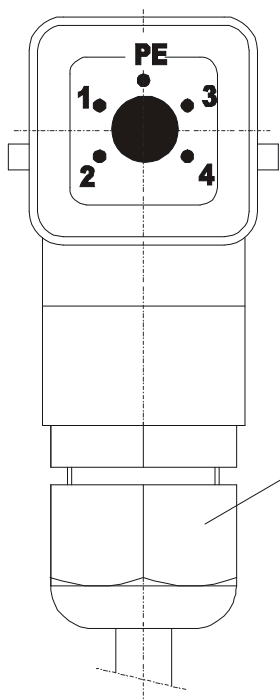

M20 gland

grey-2 100 Hz vibration frequency
 black-1 50 Hz vibration frequency
 Metal EMC gland for
 frequency-controlled systems

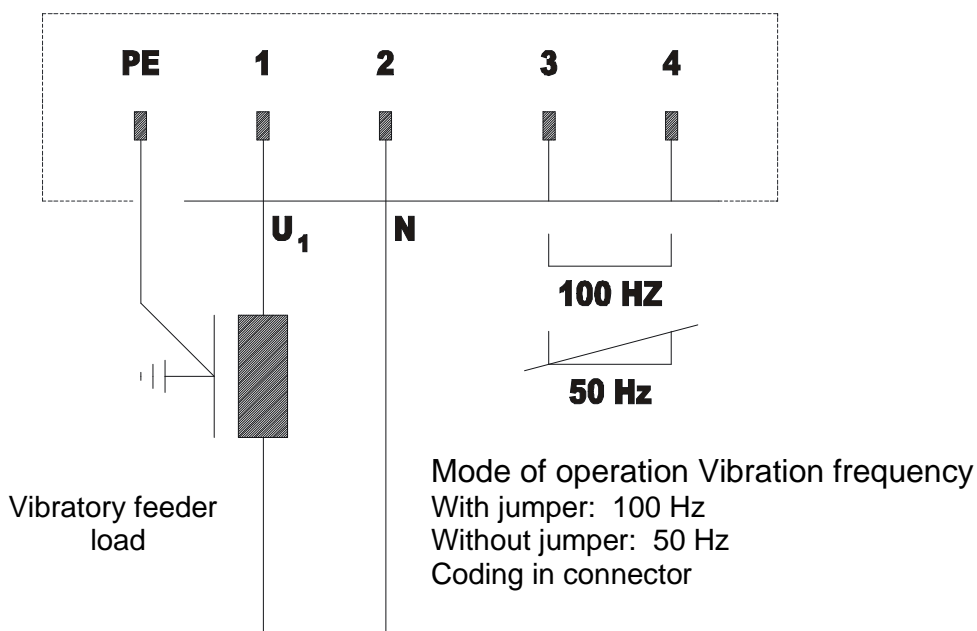

The feeders of type SLC 500 are devices with a vibration frequency of 50 Hz. The jumper between connections 4 and 5 must be removed here.

2. Safety Information

We have taken great care in design and manufacture of our linear feeder in order to ensure smooth and safe operation. You, too, can make an important contribution towards safety at work. We therefore ask you to read the brief operating instructions completely prior to commissioning the system. Observe the safety directives at all times!

Make sure that all persons working with or at the equipment also read the following safety directives carefully and follow them!

These Operating Instructions only apply to the equipment types indicated on the cover page.



Notice

This symbol indicates useful tips for operation of the linear feeder.



Attention

This warning triangle indicates safety notices. Non-observance of such warnings may cause serious injury or even death.

Machine hazards

- Hazards arise mainly from the electrical components of the linear feeder. If the linear feeder comes into contact with moisture or liquids there is risk of electric shock.
- Make sure that protective earthing of the power supply system is in perfect condition!

Intended use

The intended use of the linear feeder is the driving of feed rails. They serve for linear transfer as well as correctly oriented and metered supply of bulk products.

Intended use also includes observance of the operating instructions and compliance with the maintenance rules.

For the technical data of your linear feeder please refer to '[Technical Data](#)' in Section 1. Make sure that the rating data of the linear feeder, control system and power supply are compatible.



Notice

Operate the linear feeder in perfect condition only.

Never operate the linear feeder in areas subject to explosion hazards or in wet areas.

Operate the linear feeder only in the configuration of drive unit, control unit and vibratory system agreed with the manufacturer.

The linear feeder must never be subjected to any loads other than the parts for which this special type has been rated and dimensioned.



Attention

It is strictly forbidden to disable any guards or safety devices!

Equipment user's duties

- Observe the directives given in the operating instructions for any kind of work (operation, maintenance, repairs, etc.).
- Refrain from any working practice that affects the safety at the linear feeder.
- Make sure that only authorised personnel work at the linear feeder.
- Give immediate notice to the management of any changes that have occurred on the linear feeder affecting safety.



Attention

The linear feeder must be installed, put into operation and maintained by professional personnel only. Observe the legally binding provisions for the qualifications of qualified electrical workers and instructed workers as defined by standards IEC 364 and DIN VDE 0105, part 1.



Caution: Electromagnetic field

Magnetic fields may affect a cardiac pacemaker. Therefore, persons wearing a cardiac pacemaker are recommended to keep a distance of at least 25 cm.

Noise emission

The noise level at the place of use depends on the complete line into which the hopper will be incorporated and on the material to be conveyed. For this reason, sound pressure levels in accordance with the 'Machinery' directive can only be determined at the place of installation. If the noise level at the place of use exceeds the permissible, sound-insulating hoods can be installed which we can offer on request.

2.1. Applicable directives and standards

The linear feeder has been manufactured in accordance with the following directives:

- 2006/42/EC Machinery Directive
- 2014/35/EU Low Voltage Directive
- 2014/30/EU Electromagnetic Compatibility Directive

We assume that our product will be incorporated into a stationary machine.

The applicable standards are specified in the Declaration of Incorporation (according to Annex II B of the Machinery Directive).

3. Design and functional description of linear feeder

Intended use of linear feeders is the feeding of parts. The driving force is provided by an electromagnetic coil. The figure below is a schematic representation of a linear feeder:

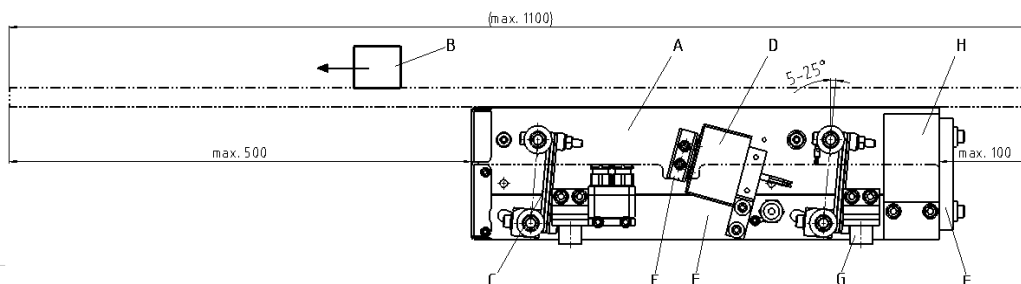

- A Feed rail and vibrating mass
- B Parts handled
- C Spring pack
- D Drive magnet
- E Armature
- Q Exciter mass
- G Shock absorber
- H Counter-balance weight

The linear feeder belongs to the family of vibratory feeders, but produces a straight-line motion. Electromagnetic oscillations are converted into mechanical vibrations that are used for conveying a material B. When current is applied to magnet D which is rigidly connected to counter mass F, the magnet exerts a force which attracts and releases armature E in synchronism with the mains frequency. Within each period of the 50 Hz A.C. mains supply, the magnet will achieve its maximum power of attraction twice as this force builds up independently of the current flow direction. Accordingly, the vibration frequency is 100 Hz in this case. If one half-wave is removed, the vibration frequency is 50 Hz. The vibration frequency of your linear feeder is indicated in the 'Technical data' table in Section 1.

A linear feeder is a resonant system (spring-mass system). As a result, its factory set-up will rarely meet your on-site requirements. Section 5 describes in detail how you can adapt the feeder to your specific requirements.

The linear feeder is controlled by a low-loss electronic control unit. This control unit is not bolted to the linear feeder but must be installed in the system by user. The controller has a 5-pin connector on its front panel for connection to the linear feeder.

For assignment of the socket pins refer to the technical data in Section 1.



Notice

For comprehensive information on the full range of control devices please refer to the 'Control Units' operating instructions.

All control units have two essential operating elements:

- The **power switch** is used to energize and de-energize the linear feeder.
- A **rotary knob** (or buttons) can be used to set the feed rate of the system.

Frequency controller

Tuning of the linear feeders can also be done by means of frequency controllers. For detailed description of the tuning procedure refer to item 5.1.2 of these operating instructions or to the frequency controller operating instructions.

4. Shipment and installation

4.1. Shipping and handling

Shipment ex works

The linear feeders are delivered ex works in a box or crate.

On-site moving

The weight of the linear feeder depends on its dimensions and motor rating. Please refer to the shipping documents for the weight of your specific equipment.



Attention

Check all guards when unpacking. Replace any damaged parts before commissioning!



Attention

For lifting the feeders be sure to use only sufficiently dimensioned vehicles, ropes, chains and sling gear.



Attention

Handling operations to be carried out only by employees who are capable of performing such work due to their own knowledge and experience in this field.



Warning

Warning against suspended loads



Notice

Take care that the linear feeder cannot collide with other objects during handling operations.

For the weight of the linear feeder please refer to the table titled 'Technical Data' in Section 1.

4.2. Installation



Attention

The linear feeder is intended to complete / to be incorporated into a complete system. Do not operate the machine before safe completion/incorporation by the user.

The linear feeder should be mounted on a stable substructure (available as an accessory) at the point of use. This substructure must be dimensioned to ensure that no vibrations from the linear feeder can be transmitted. Fix the linear feeder to the shock absorbers (part G in overview drawing of Section 3) from below. Following drawings show the dimensions for linear feeder adaptation.

Make sure that the linear feeder cannot touch other devices during operation. For further details on the control unit (drilling template, etc.), please refer to the separate operating instructions manual of the controller.

SLC 500 with shock absorbers mounted inside

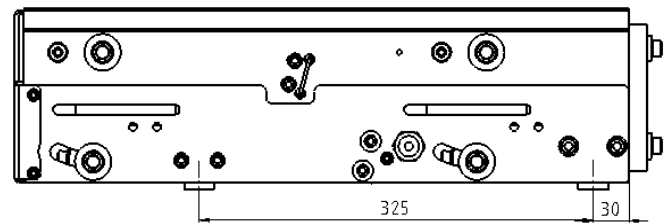
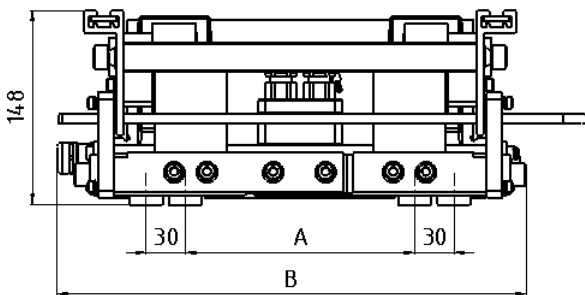

SLC 500 with shock absorbers mounted outside

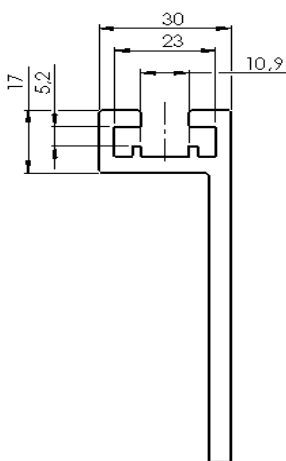
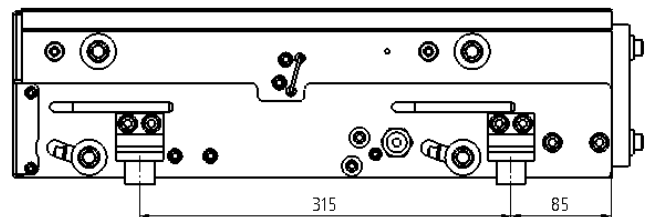
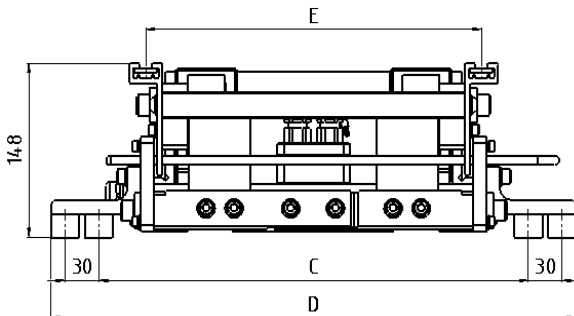

Linear feeder type	with shock absorbers mounted inside A / B	with shock absorbers mounted outside C / D	Spacing for adaptation E
SLC 500 - 200	75 / 258	284 / 369	200
SLC 500 - 300	175 / 358	384 / 469	300
SLC 500 - 400	275 / 458	484 / 569	400

Aluminium section for fastening of rails

5. Commissioning



Attention

Make sure that the machine frame (rack, substructure, etc.) is connected to the protective earth conductor (PE). Protective earthing has to be provided by user as necessary.



Attention

It is imperative that the vibrating drive be connected to the equipotential bonding system of the overall equipment before commissioning. The adaptation points are marked with earth symbols. See also: DIN EN 60204 / VDE 0100-540



Attention

Electrical connection of the linear feeder must be made by trained professional electricians only! When making any change to the electrical connection make absolutely sure that the 'Control Units' operating instructions are duly observed.

Verify that

- the linear feeder is arranged freely without contact to any solid body
- the linear rail is properly aligned and firmly bolted in place
- the linear feeder connecting cable is plugged into the control unit.
- The available electricity supply (frequency, voltage, power) must correspond to the connection data of the control system (see rating plate on the control unit).
- Plug the cable of the control unit into a power socket and operate the power switch to energize the control unit.



Notice

For linear feeders that are supplied as a completely set-up system the optimum feed rate has been factory-set. It is marked with a red arrow on the dial of the rotary knob. In this case set the rotary knob to this mark.

Optimum tuning is achieved when the desired feed rate is obtained with a control unit setting of 80 %. In case of larger deviations (> +/- 15%) you should re-tune the system.

5.1. Tuning

The following graph shows the resonance curve of a linear feeder. This information is fundamental for understanding the workings of a vibration system which is essentially made up of the vibrating masses, of a **spring constant**, and of the resulting **resonance frequency**. In operation, the **driving frequency of the current** causes the system to vibrate. These vibrations propel the parts to be conveyed at the feed rate (A). In the case of a linear feeder, there are four possibilities to tune the vibration system:

1. Changing the masses of the vibratory unit and the counter mass. This changes the resonance frequency (C)
2. Changing the spring constant by adding or removing springs This changes the resonance frequency (C)
3. The driving frequency can be changed via the frequency controller (point on the curve)
4. Adjustment of spring angle to obtain uniform feeder speed. (see section 5.3)

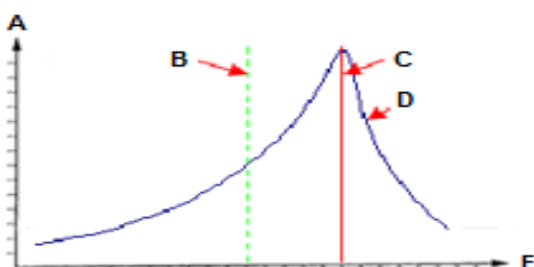

- A Feed rate
- B Desired feeder speed
- C Resonance frequency of the system
- D Resonance curve
- E Spring force (number of springs) increasing

**Notice**

The resonance frequency of the linear feeder must not coincide with the mains frequency (driving frequency). In most cases, it should be lower than this driving frequency.

When changing springs, take into account that leaves of different thicknesses have different spring forces. As the spring force increases to the square of spring thickness, please note the following examples:

- 2.5 mm spring thickness = 6.25 spring force
- 3.0 mm spring thickness = 9.0 spring force
- 3.5 mm spring thickness = 12.25 spring force

One 3.5-mm thick leaf spring produces approximately the same spring force as two 2.5 mm thick leaf springs. It is always recommended, therefore, to perform the final adjustment / fine-tuning with thin leaf springs.

**Notice**

Changing the counter mass or the vibrating mass (by adding or removing counterweights or add-on weights) will change the conveying speed or the natural frequency, respectively, of the linear feeder. If necessary, leaf springs must be added or removed.

Optimum tuning is achieved when the desired feed rate is obtained with a control unit setting of 80 %. In case of larger deviations (> +/- 15%) you should re-tune the system.

The feeder sizes come factory-equipped with a spring set designed for a feed rail weight that is approx. 25% lower than the maximum rail weight specified in the Technical Data (Section 1), and for a feeder speed of approx. 2 - 6 m/min.

If heavier or lighter feed rails are installed, or if much faster or slower feeder speeds are required, it will be necessary to change either the natural frequency of the vibrating system, or the driving frequency. If you are using a compact controller without frequency control (using 50 Hz mains power) it is mandatory to tune the system mechanically by adding or removing springs.

In conjunction with frequency controllers (such as ESR 2000) it is usually possible to dispense with mechanical tuning by adjusting the driving frequency on the controller.

The fundamentals and procedures of mechanical tuning and of frequency-based tuning are described below.

5.1.1. Mechanical tuning procedure for use with compact control unit

If the feed rail assembly or the desired feed rate of a linear feeder deviate significantly from the values stated under Technical Data, or if no frequency control unit is provided, the vibration system is tuned mechanically. As a first step it is important to determine the current tuning region of the vibration system: either the **natural frequency is less than 50 Hz** or the **natural frequency is higher than 50 Hz**. To do this, you must determine the feeder speed (using amplitude stickers) and then remove a counterweight while leaving all other settings/parameters unchanged. Now you must measure the feeder speed again. The result and the procedure to follow are shown in the table below:

Mechanical tuning of the feeder speed

Change after removal of a small counterweight	Location of natural frequency	Feeder speed to be faster	Feeder speed to be slower
Feeder speed slows down	> 50 Hz 'super-critical'	1. Refit the counterweight 2. Remove springs	1. Refit the counterweight 2. Install springs
Feeder speed increases	< 50 Hz 'sub-critical'	1. Refit the counterweight 2. Install springs	1. Refit the counterweight 2. Remove springs

**Notice**

'**Super-critical**' means that the *resonance frequency* of the vibrating system is *higher* than the frequency of the current driving the system.

'**Sub-critical**' means that the *resonance frequency* of the vibrating system is *lower* than the frequency of the current driving the system.

**Notice**

The feeder speeds that can be obtained by tuning the system in the '**super-critical**' region are lower than the speeds possible in the sub-critical region. In addition, the speed differences between loaded and unloaded feeder are bigger in this case. '**Sub-critical**' tuning should be favoured in most cases.

**Notice**

As a first step, make a rough adjustment of the feeder speed (by tuning the natural frequency). Then tune the feeding behaviour of the system. As the last step, fine-tune the feeder speed (natural frequency).

5.1.2. Tuning procedure for use with frequency-controlled control unit

Tuning by adjusting the driving frequency is also based on the fundamental principle of the resonance curve described in Section 5. Following procedure is recommended (for systems without vibration amplitude sensor) in most applications:

1. Shipping braces 'X' must be removed and all components of the rail assembly must be properly mounted.
2. Set the A value to approx. 60 % as a preliminary guideline. (Current limiter to P90% max. 205V)
3. Set the frequency to 70 Hz and power up.
4. Slowly approach 50 Hz while you continue to monitor/observe the speed all the time.
5. If the magnets hit the armatures you must lower the A value. If very little vibration occurs, increase the A value and repeat the slow, progressive approach (4).
6. Find the resonance frequency (biggest vibration amplitude) and note it down.

If the driving frequency deviates by more than +6Hz/-3Hz from the vibration frequency stated in the operating instructions manual, i.e. 50 Hz, you must install or remove springs.

7. The driving frequency for operation is now set **above** the determined resonance frequency.
8. Next, the required vibration amplitude (speed) is set via the A value.
The A value setpoint should be between 70% and 80 %.

**Notice**

For the tuning procedure of a **vibrating system with amplitude sensor** refer to the operating instructions for the respective control unit.

**Notice**

Be sure never to operate a 100 Hz linear feeder on 50 Hz. The increased current input to the linear feeder may destroy the magnet. Linear feeder SLC 500 operates at a frequency of 50 Hz.

5.2. Changing the spring configuration

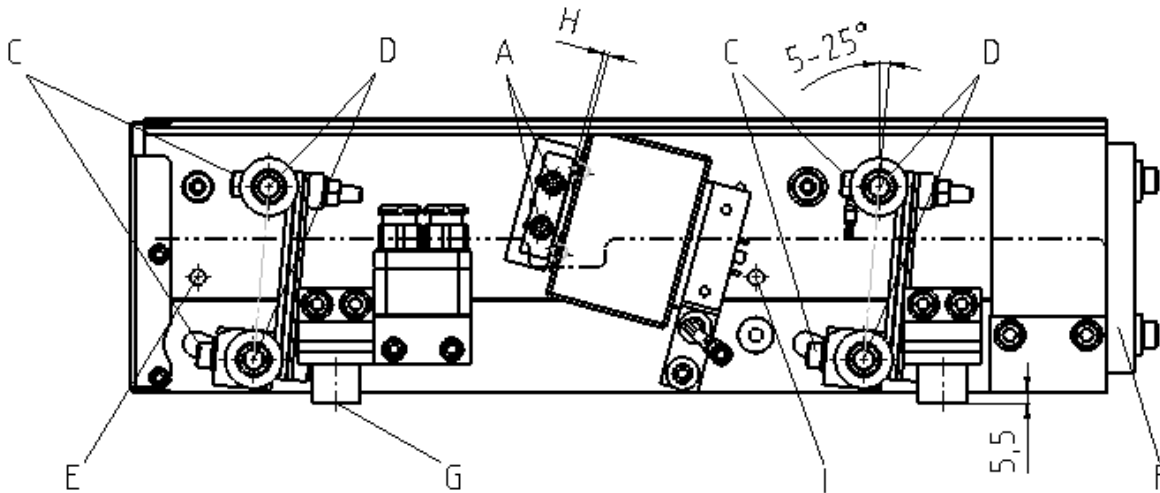

Remove the 4 upper lateral spring fastening screws 'D' (M12 x 25 DIN 912). Then disconnect grounding between vibratory unit and counter mass. Now you can lift out the complete vibratory unit, with feed rail attached. Remove the desired spring pack by loosening the lower lateral spring fastening screws 'D' (M12 X 35 DIN 912).

Screw the removed spring pack into the assembly device for a size SLC500-200/300/400 spring set and clamp the assembly device into a vise. When adding and removing leaf springs, note that spacers must be inserted between the springs.

Mutual alignment of the two spring seats is provided by the assembly device. The spring fastening screws 'C' must be tightened to a torque of 30 Nm.

Refit the complete spring pack and take care to ensure that the longer screw (M12 x 35) is in the bottom position.

In order to restore the prior alignment of the linear feeder, adjust the alignment hole relative to the vibratory unit at the upper counter mass end ('E') with the aid of a pin (8 mm diameter, minimum length 300/400/500 mm).

On the run-in side, adjust the vibratory unit by inserting another pin (8 mm diameter, minimum length 300/400/500 mm) into the alignment hole ('I') near the counterweight.

Following adjustment of the desired spring angle, you can re-tighten the lateral spring fastening screws 'D' to a torque of 80 Nm.

Now the vibratory unit is aligned to the counter mass and the locating pins can be removed.

Remember to check the coil cap 'H' and adjust it as necessary before re-starting the unit. Chapter 5.5



Notice

If the linear feeder mounting plate is designed so that crossbars are situated local to the feet, it is possible to dismount the spring packs one by one from below without removing the feeder mass (moving mass).



Attention:

Before re-starting the unit it is mandatory to re-establish protective grounding between vibratory mass and counter mass.

5.3. Adjusting the desired feeding behaviour / synchronism of the linear feed rail

For a linear feed rail to operate smoothly and in synchronism, the spring angle must be set to be identical to the centre-of-gravity angle. The centre-of-gravity angle is determined by the locations of the centres of gravity of the vibrating mass and of the counter mass.

Example based on a centre-of-gravity angle of 12.5 deg.

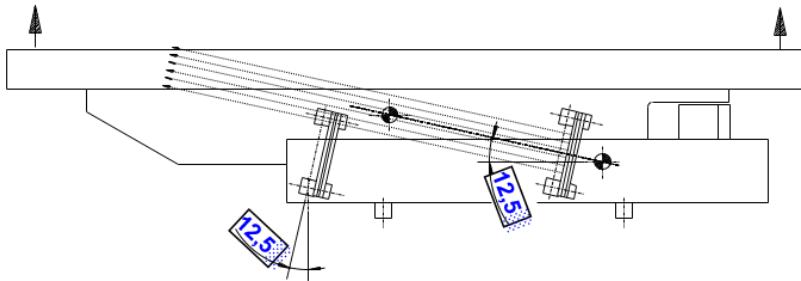

Spring angle equal to centre-of-gravity angle

The spring force is directed to attack exactly at the vibratory unit's centre of gravity. **Result:** the height amplitude is equal on the run-in and run-out sides.

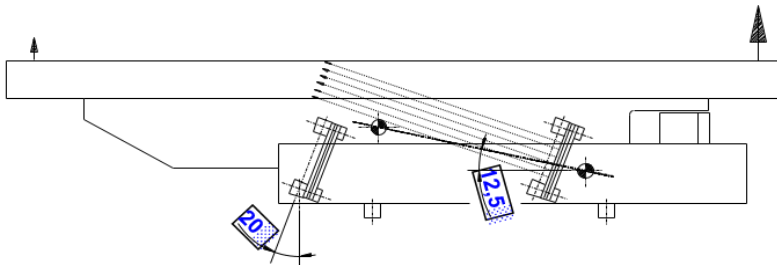

Spring angle larger than centre-of-gravity angle

The spring force is directed to attack ahead of the vibratory unit's centre of gravity. **Result:** the height amplitude on the run-in side is greater than on the run-out side.

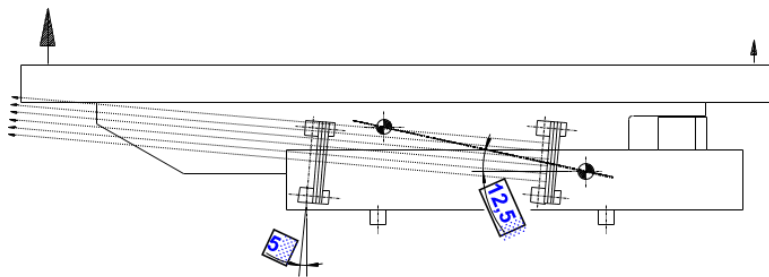

Spring angle smaller than centre-of-gravity angle

The spring force is directed to attack behind the vibratory unit's centre of gravity. **Result:** the height amplitude on the run-in side is smaller than on the run-out side.

If the two angles are not identical, the feed rail will not run smoothly. As a rule, all spring packs are to be adjusted at the same spring angle.

You can adjust the centres of gravity or spring angles, respectively, by the following means:

- Adding or removing counterweight 'H' (the mass point of the counter mass moves toward the front or rear)
- Selecting the rail height and track position so as to ensure that the mass point of the vibrating mass is considerably behind that of the counter mass (seen in feeding direction)
- Minimizing the rail weight as much as possible to move the mass point of the vibratory unit as much downwards as possible.
- Adjusting the spring angle to the angle of the mass points.

5.4. Spring angle adjustment

Fix the vibratory unit relative to the counter mass using \varnothing 8mm pins (see section 5.2 'Changing the spring set'). You can then loosen the four lateral spring fastening screws 'C' so that you can swing the spring pack to the desired spring angle. Finally re-tighten the spring fastening screws to the specified tightening torque (see Section 1, 'Technical Data') and remove the locking pins.

5.5. Adjusting the magnet air gap

The factory setting of the air gap between armature and magnet is indicated in the 'Technical data' (Section 1).

Adjustment of this air gap can be performed from the outside without dismounting any components. Slightly slacken the two exterior armature fastening screws 'A' (M6 DIN 912). Insert distance gauge into the two holes in the vibratory unit's supporting member 'H'. Adjust the air gap (see section 1, 'Technical data') by pressing down the two armature fastening screws against the direction of travel, then tightening them. (This must be done for both coils.) After that, remove the gauge. If you have no gauge on hand, you can adjust the air gap to its specified value from below using a feeler gauge or shims (if necessary, remove the entire linear feeder from its substructure or machine table).



Notice

If the rotary knob on the controller is set to 100% and the air gap correctly set, the magnet must not hit the armature upon power-on. If it does, proceed as described under section 5.2. (re-tune the drive and reduce the speed setting)

Objective of the tuning procedure:

When the desired feeding speed is obtained at a controller setting of 80%, it must increase when a weighting plate is removed. ('sub-critical')



Notice

Make sure that the number of springs per spring pack will not deviate by more than 1-2 springs.

6. Feed rail design rules

As the use of aluminium profiles makes the vibratory unit strong enough, the feed rails should be of very lightweight design. Only the rail projections beyond the vibratory unit (max. 100 mm at the entry and max. 500 mm at the exit) must be designed to resist torsional stresses involved. In order to obtain additional resistance to lateral torsion, a one-piece support plate of 12 mm thick aluminium should be bolted onto the linear feeder profiles.

The higher the feeding speed the higher the clearance should be made between top of product and bottom of feed rail cover. This clearance should be set to the largest acceptable value. When mounting the feed rail observe the following:

- Mount it closely above the top of the vibratory unit.
- Locate as precisely as possible on the aluminium profile center.
- Use stable rigid screws (M6 as a minimum).
- In order to obtain a higher feeding speed the linear feeder can be installed with a slight inclination in feeding direction (about 3 to 5 degrees).
- Never use any loose or hinged covers not firmly bolted in place.

The feed rail may be made up of several short sections to be joined and screwed in place on the vibratory unit. At the entry, flat chamfers assist product transfer from one feed rail section to another.

The split design of several sections is recommended especially for hardened or case-hardened rails (made for low distortion).

Lightweighting of feed rails can be realized by using aluminium strips or profiles. The required wear resistance can then be obtained by segments of hardened spring steel strip bolted in or on. Such segments are available from the manufacturer on request.

7. Maintenance



Attention

For installation, maintenance and repair work all poles of the power supply must be disconnected from the linear feeder in compliance with VDE provisions. Any work on electrical equipment of the linear feeder shall be carried out exclusively by a professional electrician, or by instructed persons (see chapter 2) working under the direction and supervision of a professional electrician, according to electrotechnical rules.



Attention

Be careful when working on linear feeders! The magnets can get hot during operation. Therefore let magnets cool down before working on them. If this is not possible, take suitable protective measures such as the use of gloves.



Attention

If any guards have been removed, be sure to fit them back in place!

Linear feeders basically require no maintenance. They should be cleaned when soiled or after coming into contact with liquids.

- Before starting such work be sure to pull the mains plug.
- Clean the inside of the linear feeder (dismount components as necessary), and in particular the air gap between coil and armature.
- After remounting the components and plugging in the mains plug the linear feeder is again ready for operation.

8. Spare parts and customer service

For efficient work on the linear feeders several tools are required, among others the spring stacking device, the locking pins and the coil gap gauge.

As the linear feeder is designed for a long service life, spare parts are not required frequently.

Should a defect occur nonetheless, it mostly concerns the rubber buffers or magnets.

When ordering new parts, please specify the device type (see rating plate), the spare part designation (with article code if available) and the quantity required.

For a list of Service Center addresses refer to the back cover page of this manual.

9. What if... (Advice on troubleshooting)



Attention

Only professional electricians are allowed to open the control unit or connector. Pull the mains plug before opening!

If the rail feeding speed or height amplitude is not uniform but rather higher at the exit than at the entry, this indicates that the spring angle is incorrectly set relative to the centre-of-gravity angle (see Section 5.). In this case proceed as follows:

- Increase the spring angle on all spring packs.
- Increase counterweight 'F' by attaching additional plates.

If the rail feeding speed or height amplitude is not uniform but rather higher at the entry than at the exit, this indicates that the spring angle is incorrectly set relative to the center-of-gravity angle (see Section 5.). In this case proceed as follows:

- Decrease the spring angle on all spring packs.
- Reduce counterweight 'F' by removing small weights.

If the rail speed is uniform but the running behaviour is unstable and the product jumps too much between rail contact surface and top cover, this indicates that the centre-of-gravity angle and the set spring angle of the overall system and thus the height amplitude is too large. In this case proceed as follows:

- Change the centre-of-gravity angle (more 'flat') by shifting the counterweight 'F' against the feeding direction, attaching additional weighting plates to the counterweight, installing the additional weight into the vibratory unit supporting member and making the feed rail lighter, if necessary.
- Adjust the spring angle to match the new centre-of-gravity angle.

If despite uniform height amplitude the running behaviour is unstable, especially with product having a large contact area or oil-contaminated parts, this indicates that the centre-of-gravity angle and the set spring angle of the entire system is too small. The height amplitude is too small. This prevents the throwing motion and in case of oily product the adhesive force is higher than the throwing force, i.e. the product cannot take off. In this case proceed as follows:

- Change the centre-of-gravity angle (more 'steep') by shifting the counterweight 'F' in feeding direction, removing weighting plates from the counterweight and removing the additional weight from the vibratory unit supporting member.
- Adjust the spring angle to match the new centre-of-gravity angle.

If it is impossible to set-up the feed rail properly by following the above procedures and if lateral oscillation occurs or 'dead spots' are found in certain areas, then the stiffness of the rail is insufficient. The abutment joints move relative to one another or non-symmetric rail sections lead to non-uniform running behaviour. In this case proceed as follows:

- Fit additional reinforcing ribs and screw abutment joints together.
- Counter-balance non-symmetric sections by weights or replace by material lighter in weight.

Fault	Potential cause	Remedy
Linear feeder does not start on power up	Power switch off Mains connector of control unit not plugged-in Connecting cabled between linear feeder and control unit not plugged-in Defective fuse in control unit	Close power switch Plug in the mains connector Plug 5-pin connector into control unit Replace fuse
Only slight feeder vibration 	Rotary knob on control unit set at 0 % Shipping locks or braces not removed Wrong vibration frequency	Set control unit to 80 % Remove shipping locks or braces. Check that coding in plug connector of the linear feeder is correct (see rating plate and 'Technical Data' (Section 1))
The linear feeder no longer meets the required feed rate after prolonged operation.	Fixing screws of linear rail have come loose. Screws of one or more spring packs have come loose. Misadjusted coil-to-armature air gap Vibratory unit displaced towards the counter mass	Re-tighten the screws. Tighten screws (for tightening torques see 'Technical Data' in Section 1). Readjust the coil-to-armature air gap (for air gap size see 'Technical Data' in Section 1). Re-adjust the vibratory unit (see Section 5).
Linear feeder makes loud noises.	Foreign matter in air gap	Stop linear feeder and remove foreign matter. Then check the coil-to-armature gap.
Linear feeder cannot be tuned to a constant speed for longer periods of time.	The spring constant of the vibrating system has changed. The linear feeder operates close to the resonance point.	Re-tune the linear feeder. Remove springs. See Section 5: Tuning



Headquarters

Rhein-Nadel Automation GmbH
Reichsweg 19-23
D-52068 Aachen
Phone: +49 (0)241-5109-0
E-mail: vertrieb@RNA.de
www.RNA.de

Further RNA group companies:



PSA Zuführtechnik GmbH
Steinäckerstraße 7
D-74549 Wolpertshausen
Phone: +49 (0)7904-94336-0
E-mail: info@psa-zt.de
www.psa-zt.de



RNA Automation Ltd.
Unit C Castle Bromwich Business Park
Tameside Drive Birmingham B35 7AG
Great Britain
Phone: +44 (0)121-749-2566
E-Mail: sales@rnaautomation.com
www.rnaautomation.com



HSH Handling Systems AG
Wangenstraße 96
3360 Herzogenbuchsee
Switzerland
Phone: +41 (0)62-956 10-00
E-mail: info@handling-systems.ch
www.handling-systems.ch



RNA Vibrant S.A.
Carrer de l'Energia
08940 Cornellà de Llobregat (Barcelona)
Spain
Phone: +34 (0)93-377-7300
E-mail: info@vibrant-RNA.com
www.vibrant-RNA.com



RNA Digital Solutions GmbH
Reichsweg 19-23
D-52068 Aachen
Phone: +49 (0)1515-99 28 255
E-mail: kontakt@rnadigital.de
www.designforfeeding.com
www.rnadigital.de

Further manufacturing sites of the RNA Group

Lüdenscheid site

Rhein-Nadel Automation GmbH
Nottebohmstraße 57
D-58511 Lüdenscheid
Phone: +49 (0) 2351 -41744
E-mail: werk.luedenscheid@RNA.de

Ergolding site

Rhein-Nadel Automation GmbH
Ahornstraße 122
D-84030 Ergolding
Phone: +49 (0) 871 -72812
E-mail: werk.ergolding@RNA.de

Remchingen site

Rhein-Nadel Automation GmbH
Im Hölderle 3
D-75196 Remchingen-Wilferdingen
Phone: +49 (0)7232-7355-558
E-mail: werk.remchingen@RNA.de